

Sample Order / Cheat Sheet
T Lighting 1/4

QUOTE ORDER

NAME: _____

PO#: _____

ADDRESS: _____

DELIVERY: _____

ADDRESS: _____



ORDER DATE: _____

OFFICE PHONE: _____

CONTACT: _____

FAX PHONE: _____

JOB NAME: _____

JOB PHONE: _____

HARDWARE WORK ORDER

TOLL FREE 888.788.2013 OR 208.788.2013; FAX 208.788.2577

LINE #	FUNCTION	FIXTURE	ESCUTCHEON	METAL	PATINA	LENGTH	OPTIONS	SHADE OPTIONS	DESCRIPTION	LOCATION	QUANTITY	PRICE QUOTED
1	LT	PE435-LED	E403	B	BB					101	1	\$2,264.00
2	LT	WS410	E155	W	M				LBK	101	1	\$2,179.00
3	LT	V450	E419	B	D	26				112	1	\$3,467.00
4	LT	WS421	G520	W	BB					100	1	\$2,094.00
5	LT	C500		W	D	60	C, P	CSW		125	1	\$12,965.00
6	LT	C450	G4513	B	L	104				127	1	\$8,434.00

FUNCTION

LT-D = Lighting,
Damp Location
LT-W = Lighting,
Wet Location
AC = Accessory

FIXTURE

See following page.

ESCUTCHEONS

E155 = 5 1/2" x 5 1/2"
Square Designer
E280 = 5 1/2" x 5 1/2" Metro
E403 = 5 1/2" x 5 1/2" Square
E419 = 6 1/2" Round
E560 = 6 1/2" x 13" Oval
G153 = 5 1/2" x 13"
Rectangular Designer
G290 = 5 1/2" x 13" Metro
G291 = 4" x 30" Metro
G504 = 23/4" x 20" Curved
G520 = 5" x 20" Curved
G4513 = 5 1/2" x 13"
Rectangular

METAL

B = Silicon Bronze
W = White Bronze

PATINA

L = Light
M = Medium
D = Dark
R = Rust
BB = Brushed
DL = Dark Lustre
HP = High Polished *
*Up-charge applies.

LENGTH

Vanity V450 & V455
26 = 26"
40 = 40"
54 = 54"
68 = 68"
82 = 82"
94 = 94"
Chandelier C450 & C455
Specify up to 104"
Chandelier C500
Specify up to 77"
Chandelier C525
Specify up to 73"

OPTIONS

C = Crystals
P = Prisms

SHADE OPTIONS

CSW = Cone Shade White
CSF = Cone Shade Flax
CST = Cone Shade Taupe
CSB = Cone Shade Black
DSW = Drum Shade White
DSF = Drum Shade Flax
DST = Drum Shade Taupe
DSB = Drum Shade Black
DS2W = Drum Shade 2 White
DS2F = Drum Shade 2 Flax
DS2T = Drum Shade 2 Taupe
DS2B = Drum Shade 2 Black

DESCRIPTION

Leather Options
LBK = Black Leather
LBT = Brown Tapestry Leather
LBW = Brown Weave Leather
LCH = Chocolate Leather
LHA = Hazelnut Leather
LSP = Spice Leather
LWH = White Leather
LWI = Wine Leather

Texture Options Not Available

LOCATION #

Room Number or Door Number,
etc.

QUANTITY

Number of each desired

QUOTED PRICE

\$ List price each

LIGHTING FIXTURE

- C400FB = Cube Chandelier with Flat Box
- C400CB = Cube Chandelier with Corrugated Box
- C405FB = Double Cube Chandelier with Flat Box
- C420 = Linear Chandelier
- C450* = Cross Arm Chandelier with Round Glass
- C455* = Cross Arm Chandelier with Square Glass
- C500* = 5-Arm Chandelier
- C525* = 3-Arm Chandelier

- CF485 = Crosby Ceiling Light

- LG400 = Pathway Light

- PE425 = Foxtrot Pendant
- PE430 = Delta Pendant
- PE435 = Charlie Pendant
- PE450 = Bravo Pendant
- PE455 = Alpha Pendant
- PE465 = Echo Pendant
- PE490 = Luna Pendant
- PE523 = Ethel Pendant
- PE525 = Lucy Pendant
- PE530 = Cargo Pendant
- PE532 = Madison Pendant
- PE625 = Torch Pendant
- PE627 = Icicle Pendant

- V440 = Triple Plank with Flat Glass
- V445 = Triple Plank with Corrugated Glass
- V450* = Lantern Vanity with Round Glass
- V455* = Lantern Vanity with Square Glass

- WS400 = Post Sconce with Round Glass
- WS405 = Post-Ring Sconce with Round Glass
- WS410 = Truss Sconce with Round Glass
- WS415 = Truss-Ring Sconce with Round Glass
- WS416 = Truss Sconce with Square Glass
- WS418 = Truss-Ring Sconce with Square Glass
- WS419 = Charlie Sconce
- WS420 = Double Tunnel Sconce
- WS421 = Mod Sconce
- WS423 = Double Charlie Sconce
- WS425 = Small Vessel Sconce
- WS430 = Vessel Sconce
- WS440 = Plank Sconce with Flat Glass
- WS445 = Plank Sconce with Corrugated Glass
- WS465 = Lantern Sconce
- WS466 = Dice Sconce
- WS468 = Gateway Sconce
- WS480 = Tunnel Sconce
- WS500 = Towne Sconce
- WS590 = Echo Sconce

DESCRIPTION

Glass Shades — Replacement

- Corrugated Flat 20
- Corrugated Plank 20
- Curve Slump 3.5
- Curve Slump 4
- Flat 20
- Flat 40
- Flat 50
- Globe 001
- Globe 002
- Globe 004
- Globe 001-W
- Globe 004-W
- Globe 005
- Globe 010
- Mod Glass
- Plank 20
- Shade 425
- Shade 6
- Shade 10
- Square Slump 7
- S Tube 001
- S Tube 003

*See page Ti for available lengths.

Sample Order / Cheat Sheet
T Lighting 3/4

ESCUTCHEON CHOICES

UL RATING

LIGHTING OPTIONS		ESCUTCHEON CHOICES											UL RATING		
FIXTURE	PART	G4513 5 1/2 X 13	E403 5 1/2 SQ	E560 6 1/2 X 13	E419 6 1/2 RD	G290 5 1/2 x 13	E280 5 1/2 SQ	G153 5 1/2 X 13	E155 5 1/2 SQ	G504 2 3/4 X 20	G520 5 X 20	G291 4 X 30	DAMP	WET	LED
CUBE CHANDELIER FLAT GLASS	C400FB	•				•		•					•		•
CUBE CHANDELIER CORRUGATED GLASS	C400CB	•				•		•					•		•
DOUBLE CUBE CHANDELIER FLAT GLASS	C405FB		•		•		•		•				•		
LINEAR CHANDELIER	C420		•		•		•		•						•
CROSS ARM CHANDELIER ROUND GLASS	C450	•				•		•					•		•
CROSS ARM CHANDELIER SQUARE GLASS	C455	•				•		•					•		•
FIVE-ARM CHANDELIER TOWNE	C500				•								•		
THREE-ARM CHANDELIER TOWNE	C525				•								•		
ALPHA PENDANT SQUARE GLASS	PE455		•		•		•		•				•		•
BRAVO PENDANT ROUND GLASS	PE450		•		•		•		•				•		•
CHARLIE PENDANT SQUARE GLASS	PE435		•		•		•		•				•		•
FOXTROT PENDANT SQUARE GLASS	PE425		•		•		•		•				•		•
DELTA PENDANT SQUARE GLASS	PE430		•		•		•		•				•		•
ECHO PENDANT SQUARE GLASS	PE465		•		•		•		•				•		•
LUNA PENDANT	PE490		•		•		•		•				•		
ETHEL PENDANT	PE523				•				•				•		•
LUCY PENDANT	PE525				•				•				•		•
CARGO PENDANT ROUND GLASS	PE530		•		•		•						•		
MADISON PENDANT	PE532		•		•		•						•		•
TORCH PENDANT	PE625		•		•		•		•				•		•
IGICLE PENDANT	PE627		•		•		•		•				•		•
LANTERN VANITY ROUND GLASS	V450 26-94		•		•		•		•				•		•
LANTERN VANITY SQUARE GLASS	V455 26-94		•		•		•		•				•		•
TRIPLE PLANK FLAT VANITY	V440												•		•
TRIPLE PLANK VANITY CORRUGATED	V445												•		•
PLANK SCONCE FLAT GLASS	WS440												•		•
PLANK SCONCE CORRUGATED GLASS	WS445												•		•
POST SCONCE ROUND GLASS	WS400	•	•	•	•	•	•	•	•				•	•	•
POST RING SCONCE ROUND GLASS	WS405	•	•	•	•	•	•	•	•				•	•	•
TRUSS SCONCE ROUND GLASS	WS410	•	•	•	•	•	•	•	•				•	•	•
TRUSS RING SCONCE ROUND GLASS	WS415	•	•	•	•	•	•	•	•				•	•	•
TRUSS SCONCE SQUARE GLASS	WS416	•	•	•	•	•	•	•	•				•	•	•
TRUSS RING SCONCE SQUARE GLASS	WS418	•	•	•	•	•	•	•	•				•	•	•
CHARLIE SCONCE SQUARE GLASS	WS419	•	•	•	•	•	•	•	•				•		•

- These fixtures must be mounted or supported independently of an outlet box.
- Glass is individually hand formed for every fixture, thus no two pieces will look exactly alike.

Light Emitting Diodes (LED) Lighting Information

- Fixtures with LED options carry an up charge
- Dimmable
- Low Voltage
- Green—no lead no mercury
- 50,000 hours of lamp life
- Instant on/off performance
- Energy savings up to 80%
- Meets California's Title 24 lighting requirements

ESCUTCHEON CHOICES

UL RATING

LIGHTING OPTIONS		G4513	E403	E560	E419	G290	E280	G153	E155	G504	G520	G291	DAMP	WET	LED
FIXTURE	PART	5 1/2 X 13	5 1/2 SQ	6 1/2 X 13	6 1/2 RD	5 1/2 x 13	5 1/2 SQ	5 1/2 X 13	5 1/2 SQ	2 3/4 X 20	5 X 20	4 X 30			
DOUBLE TUNNEL SCONCE	WS420											•	•		•
ECHO SCONCE SQUARE GLASS	WS590	•	•	•	•	•	•	•	•				•		•
LANTERN SCONCE	WS465	•	•			•	•						•	•	•
MOD SCONCE	WS421									•	•		•		•
DOUBLE CHARLIE SCONCE	WS423		•		•		•		•			•	•		•
SMALL VESSEL SCONCE	WS425												•		•
LARGE VESSEL SCONCE	WS430												•		•
TUNNEL SCONCE	WS480												•		•
TOWNE SCONCE	WS500	•	•	•	•	•	•	•	•				•		•
DICE SCONCE	WS466												•		•
GATEWAY SCONCE	WS468												•		•
PATHWAY LIGHT	LG400													•	•
CROSBY CEILING LIGHT	CF485												•		•

- These fixtures must be mounted or supported independently of an outlet box.
- Glass is individually hand formed for every fixture, thus no two pieces will look exactly alike.

Light Emitting Diodes (LED) Lighting Information

- Fixtures with LED options carry an up charge
- Dimmable
- Low Voltage
- Green—no lead no mercury
- 50,000 hours of lamp life
- Instant on/off performance
- Energy savings up to 80%
- Meets California's Title 24 lighting requirements

- It is the responsibility of the contractor and homeowner to confirm that the light fixture is properly installed.
- All fixtures are to be installed by a qualified electrician.
- All fixtures must be mounted or supported independently of an outlet box.

INCANDESCENT: CHANDELIER AND PENDANT ELECTRICAL BOX LOCATION:

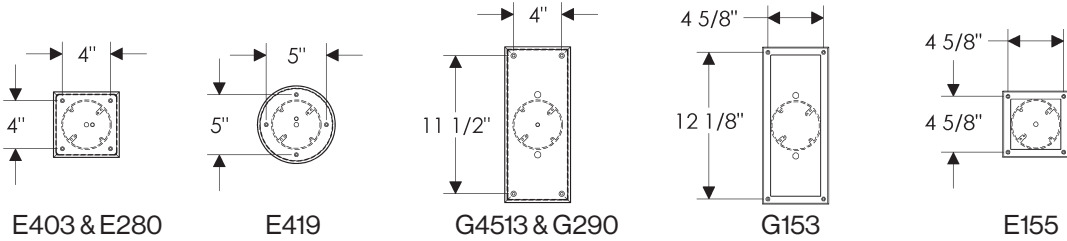

- It is the responsibility of the contractor and homeowner to confirm that the light fixture is properly installed.
- All fixtures are to be installed by a qualified electrician.
- All fixtures must be mounted or supported independently of an outlet box.
- WS421 requires a single gang electrical box.

INCANDESCENT: WALL SCONCE AND VANITY ELECTRICAL BOX LOCATION:

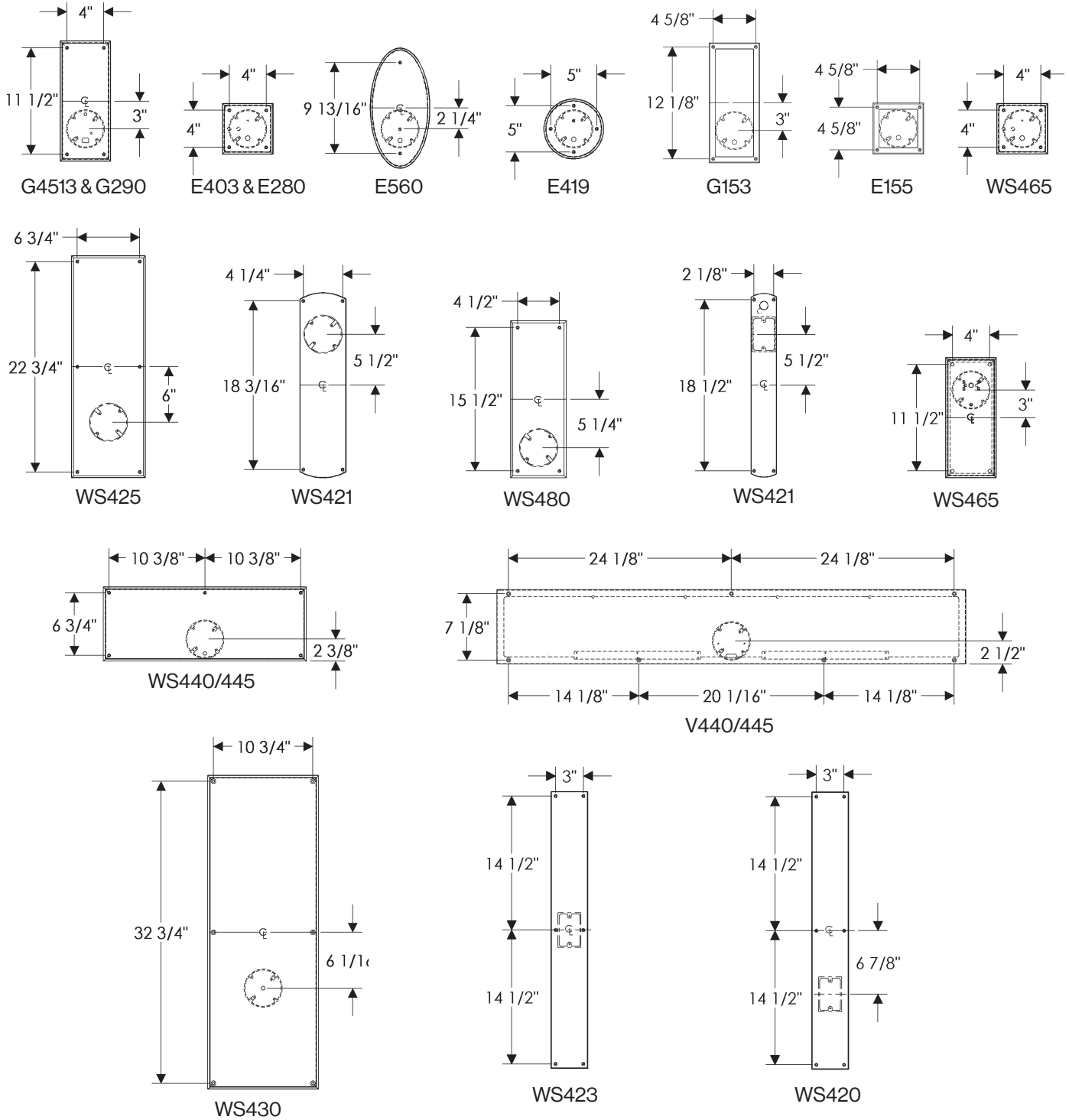

- It is the responsibility of the contractor and homeowner to confirm that the light fixture is properly installed.
- All fixtures are to be installed by a qualified electrician.
- All fixtures must be mounted or supported independently of an outlet box.

LED: CHANDELIER AND PENDANT ELECTRICAL BOX LOCATION:

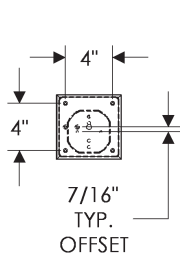

E403 & E280

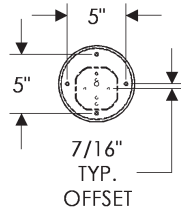

E419

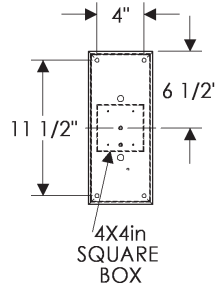

G4513, G290,
E280

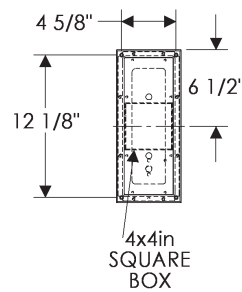

G153

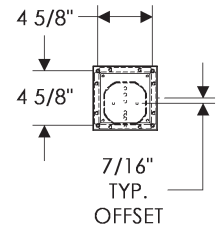

E155

- It is the responsibility of the contractor and homeowner to confirm that the light fixture is properly installed.
- All fixtures are to be installed by a qualified electrician.
- All fixtures must be mounted or supported independently of an outlet box.
- WS421 and WS423 require a single gang extra deep volume electrical box.

LED: WALL SCONCE AND VANITY ELECTRICAL BOX LOCATION:

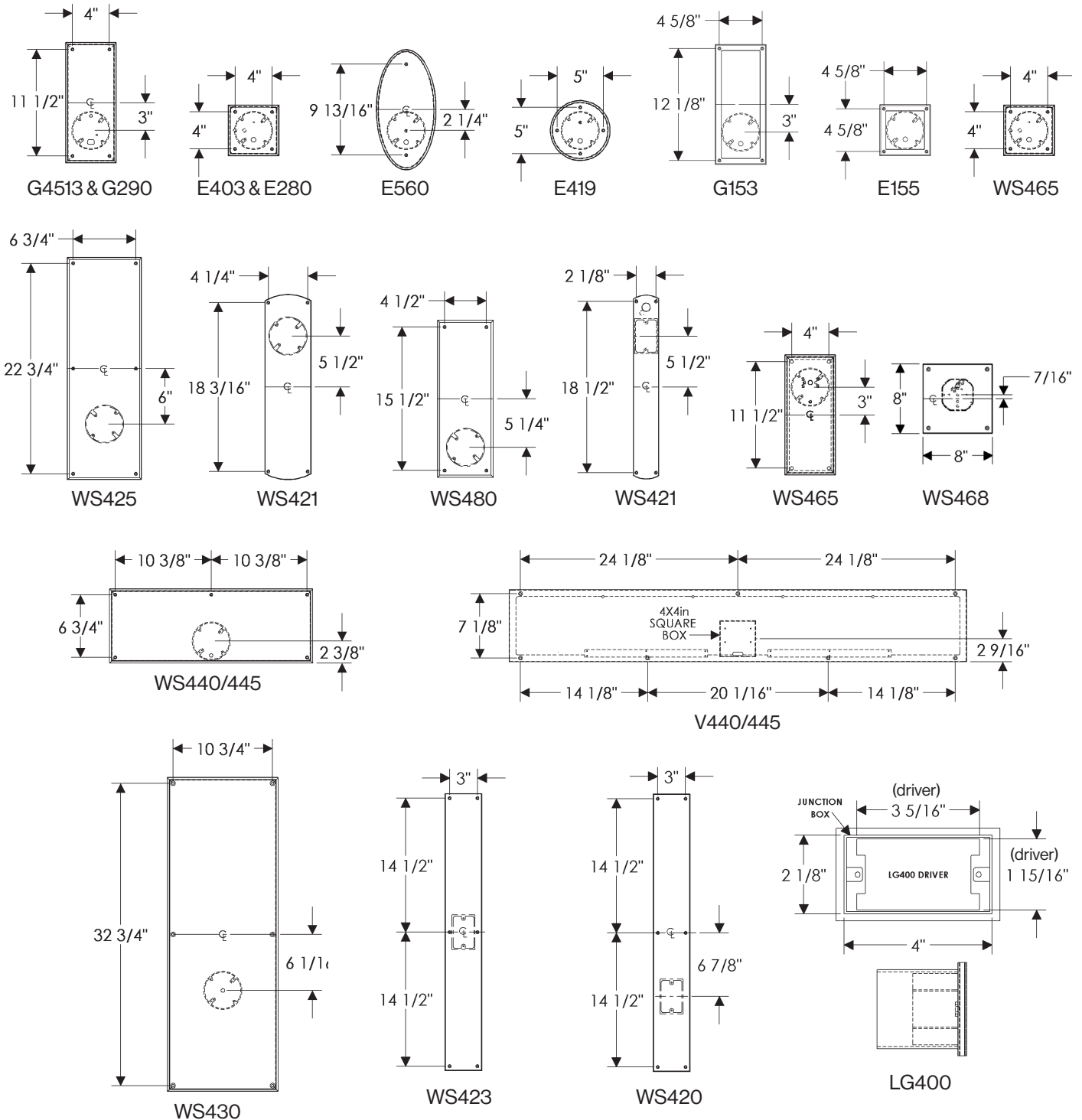

- It is the responsibility of the contractor and homeowner to confirm that the light fixture is properly installed.
- All fixtures are to be installed by a qualified electrician.
- All fixtures must be mounted or supported independently of an outlet box.

INCANDESCENT: VANITY ELECTRICAL BOX LOCATION: E403 & E280

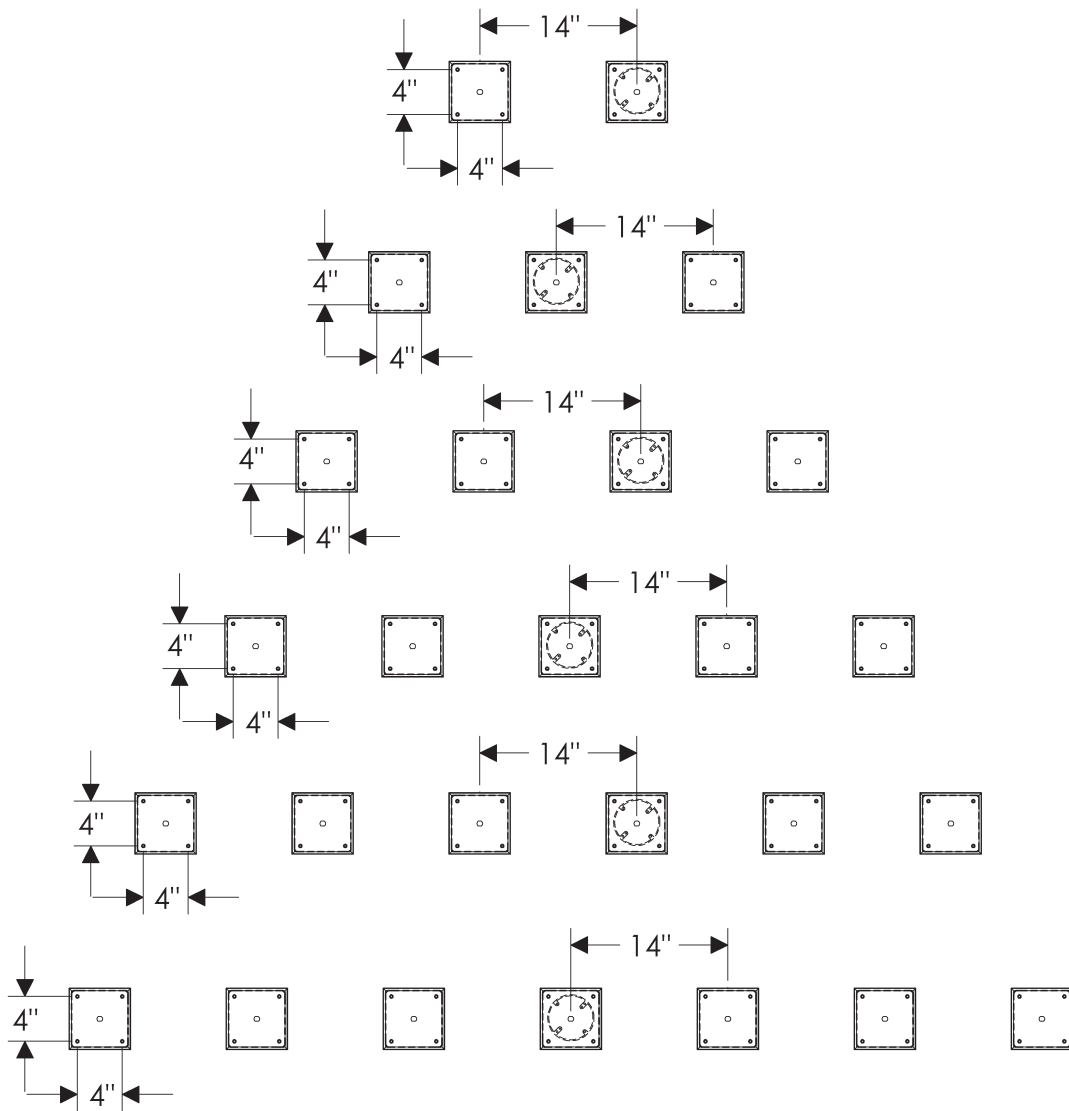

- It is the responsibility of the contractor and homeowner to confirm that the light fixture is properly installed.
- All fixtures are to be installed by a qualified electrician.
- All fixtures must be mounted or supported independently of an outlet box.

LED: VANITY ELECTRICAL BOX LOCATION: E403 & E280

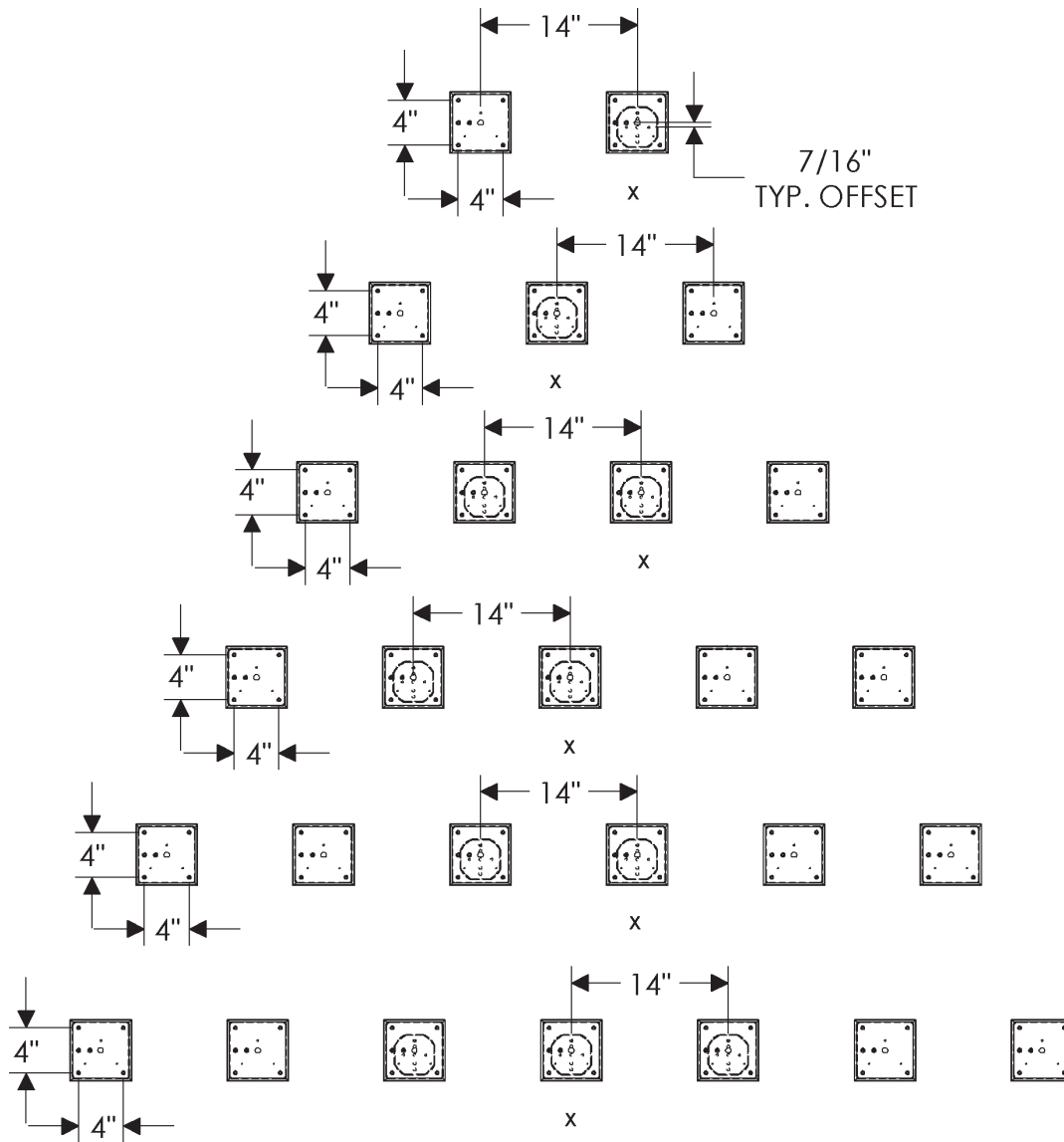

x denotes electrical box location
inwall—other boxes show
location of LED housing.

- It is the responsibility of the contractor and homeowner to confirm that the light fixture is properly installed.
- All fixtures are to be installed by a qualified electrician.
- All fixtures must be mounted or supported independently of an outlet box.

INCANDESCENT: VANITY ELECTRICAL BOX LOCATION: E419

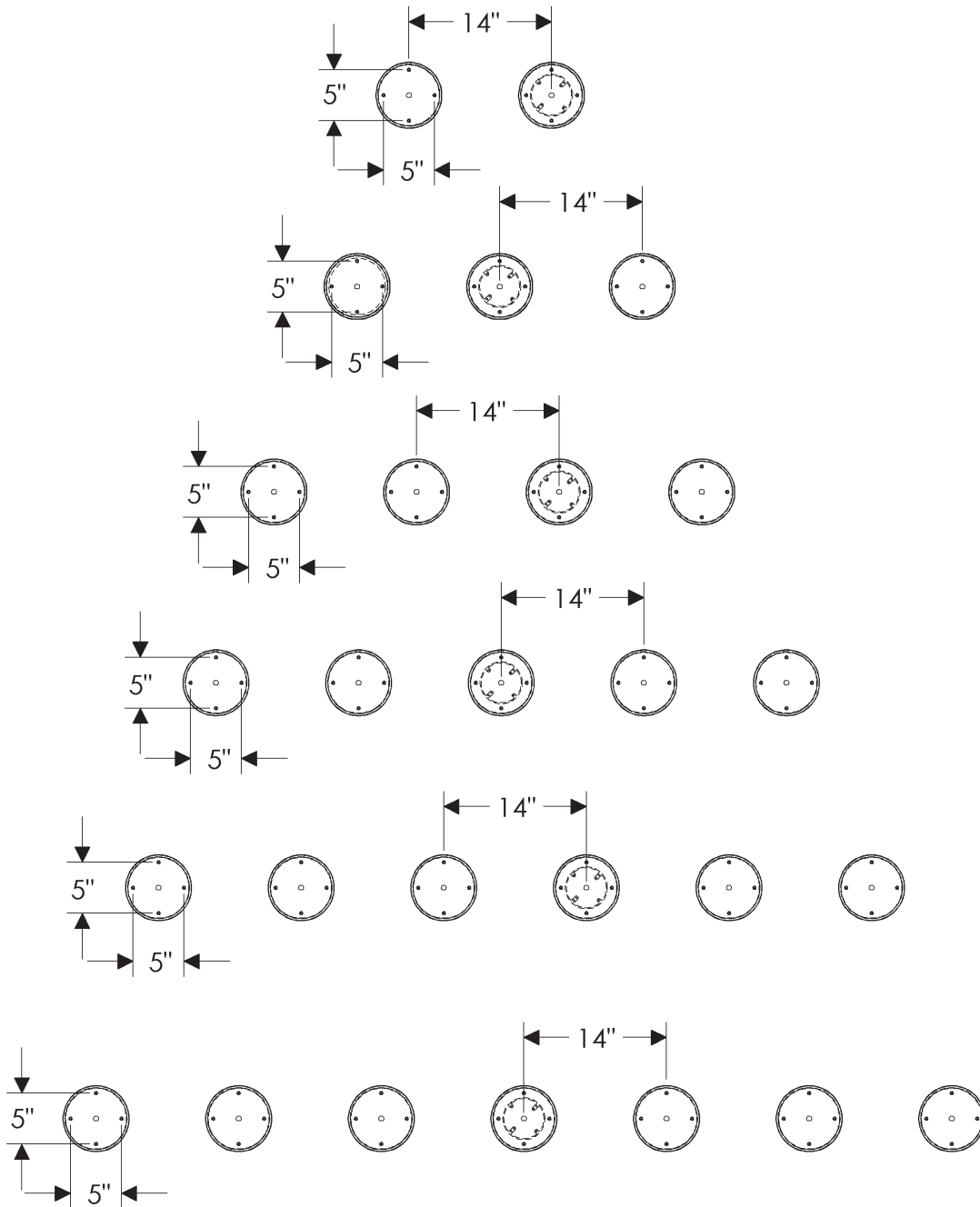

- It is the responsibility of the contractor and homeowner to confirm that the light fixture is properly installed.
- All fixtures are to be installed by a qualified electrician.
- All fixtures must be mounted or supported independently of an outlet box.

LED: VANITY ELECTRICAL BOX LOCATION: E419

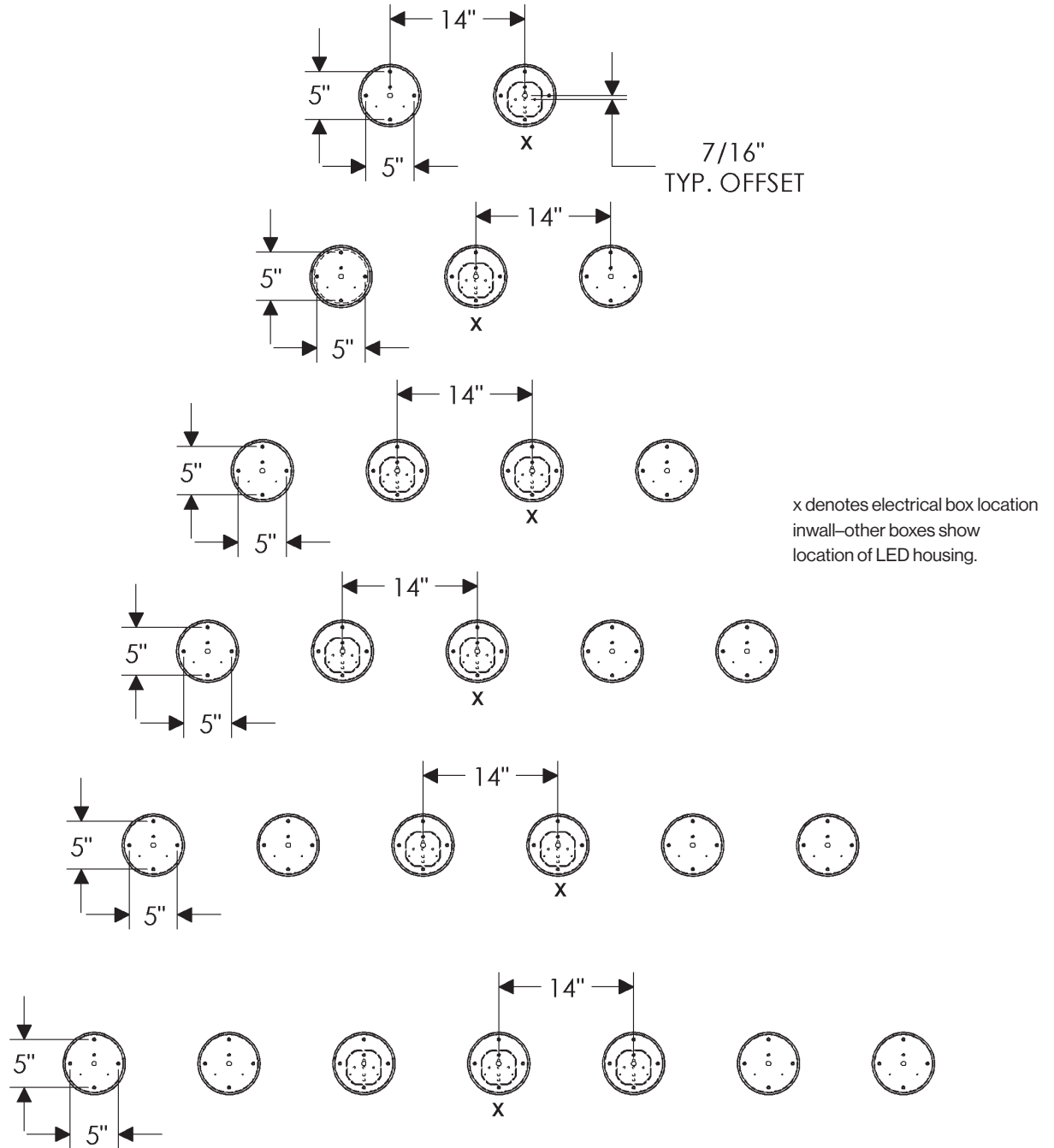

- It is the responsibility of the contractor and homeowner to confirm that the light fixture is properly installed.
- All fixtures are to be installed by a qualified electrician.
- All fixtures must be mounted or supported independently of an outlet box.

INCANDESCENT: VANITY ELECTRICAL BOX LOCATION: E155

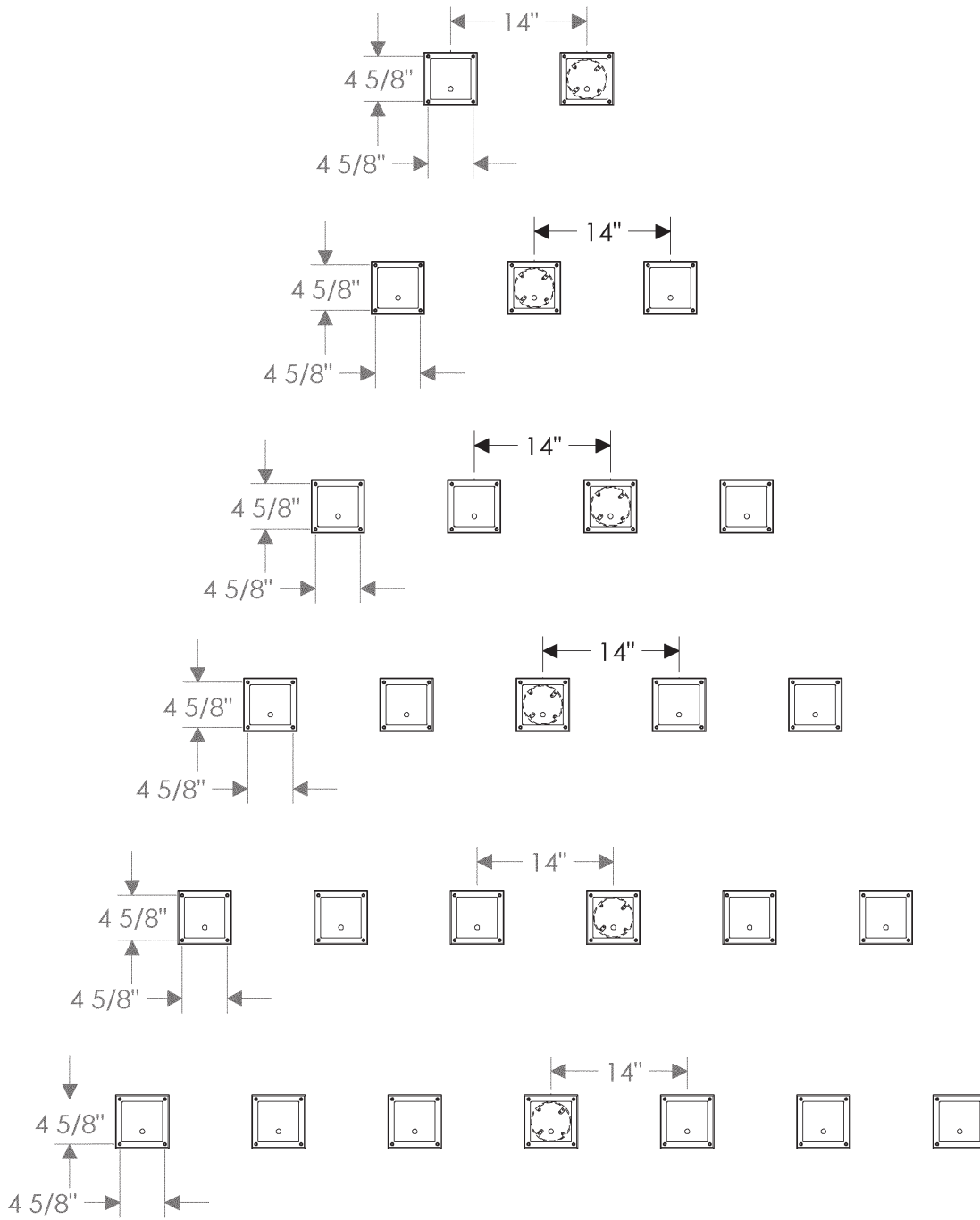

- It is the responsibility of the contractor and homeowner to confirm that the light fixture is properly installed.
- All fixtures are to be installed by a qualified electrician.
- All fixtures must be mounted or supported independently of an outlet box.

LED: VANITY ELECTRICAL BOX LOCATION: E155

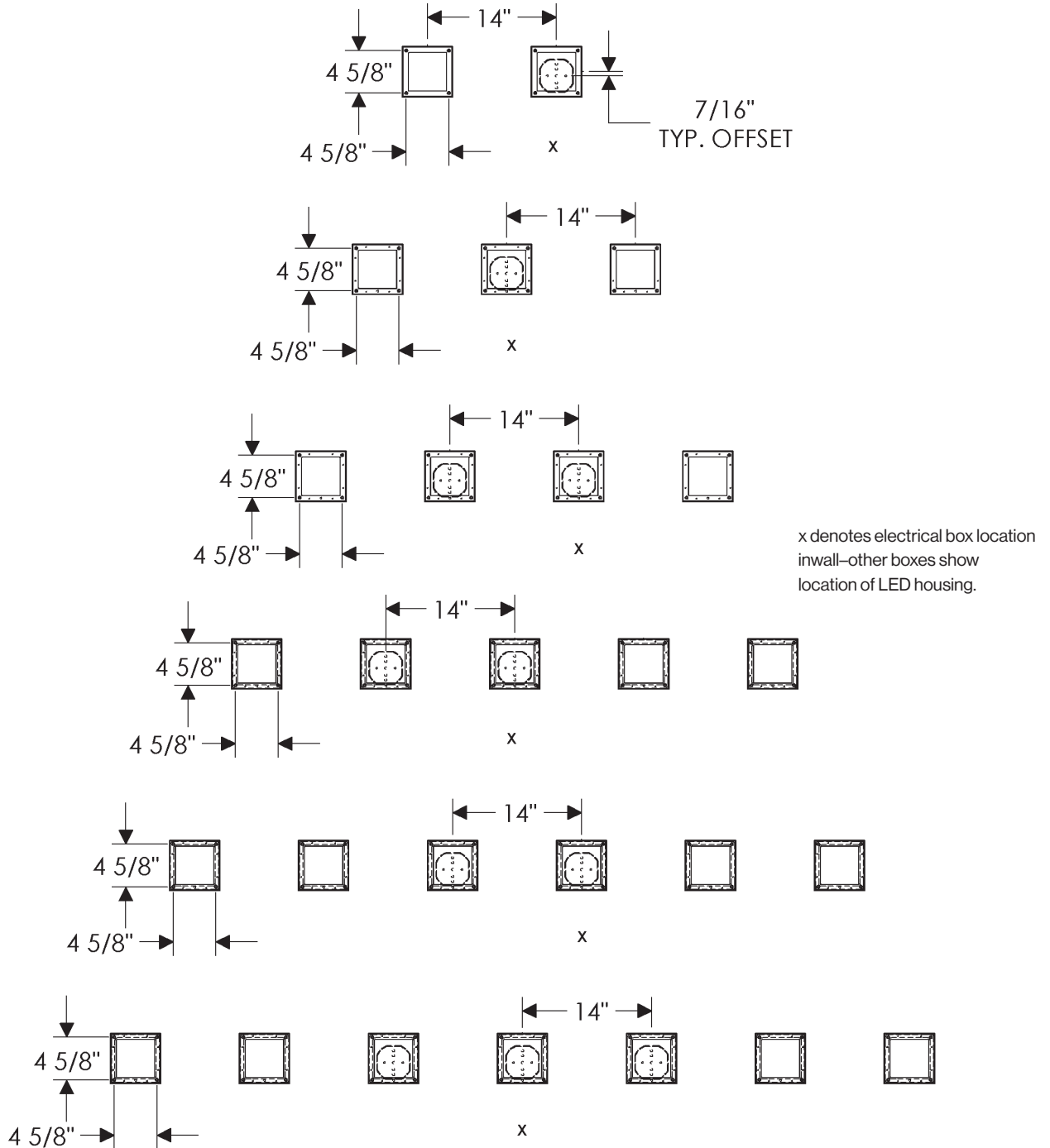

- All shades are hand-blown and hand-crafted glass. The size and surface finish may vary.
- All fixtures are provided with shades. These shades are listed for replacement only.

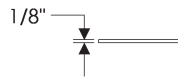
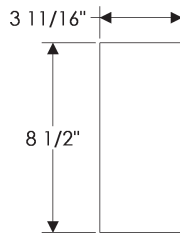

Mod Glass
3 11/16" x 8 1/2" x 1/8"..... \$ 25.00 net

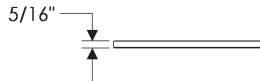
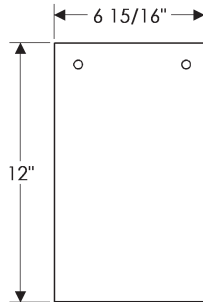

Shade 10
6 15/16" x 12" x 5/16"..... \$ 68.00 net

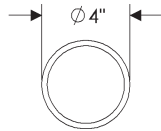
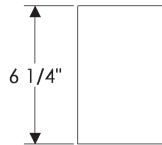
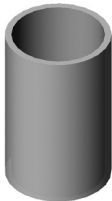

Globe 001
4" x 6 1/4"..... \$ 95.00 net

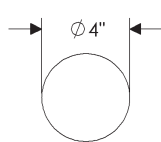
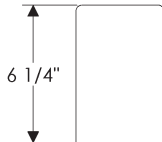

Globe 001-W
4" x 6 1/4"..... \$ 95.00 net

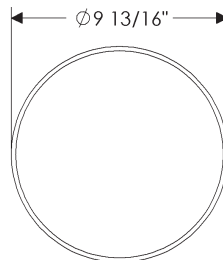
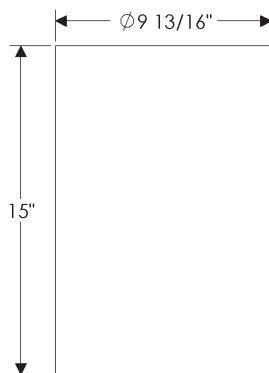
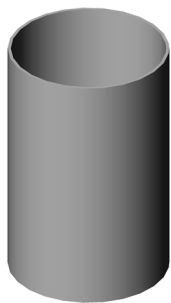

Globe 010
9 13/16" x 15"..... \$ 545.00 net

- All shades are hand-blown and hand-crafted glass. The size and surface finish may vary.
- All fixtures are provided with shades. These shades are listed for replacement only.

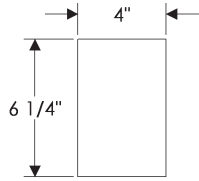
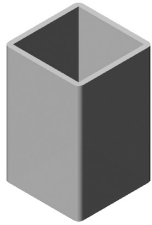

Globe 004
4" x 4" x 6 1/4" \$ 95.00 net

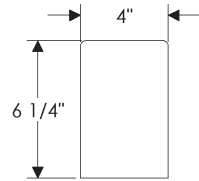
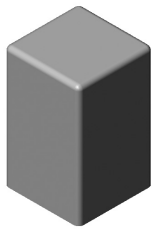

Globe 004-W
4" x 4" x 6 1/4" \$ 95.00 net

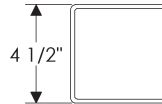
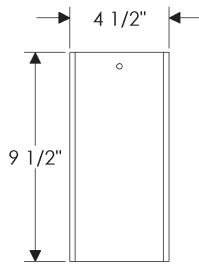
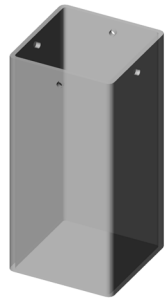

Globe 002
4 1/2" x 9 1/2" x 4 1/2" \$ 218.00 net

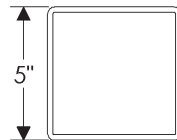
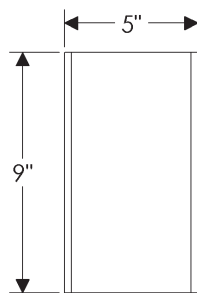
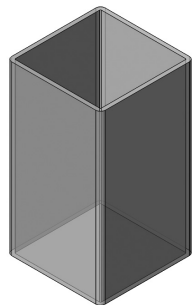

Globe 005
5" x 9" x 5" \$ 267.00 net

- All shades are hand-blown and hand-crafted glass. The size and surface finish may vary.
- All fixtures are provided with shades. These shades are listed for replacement only.

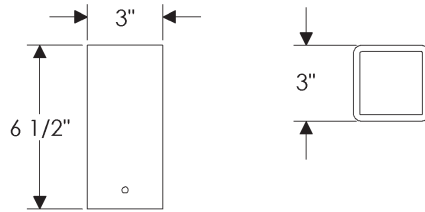
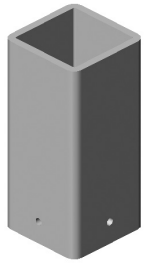

S Tube 001
3" x 3" x 6 1/2" \$ 95.00 net

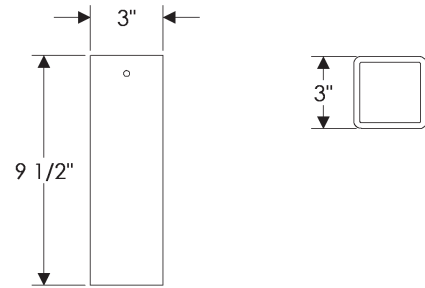

S Tube 003
3" x 3" x 9 1/2" \$ 95.00 net

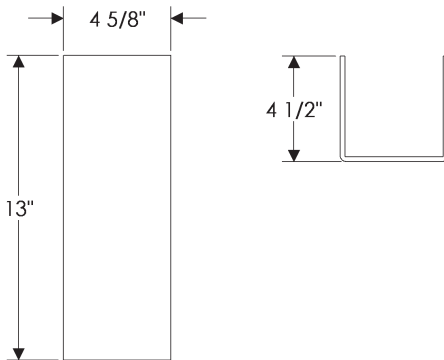

Shade 425
4 5/8" x 13" x 4 1/2" \$ 182.00 net

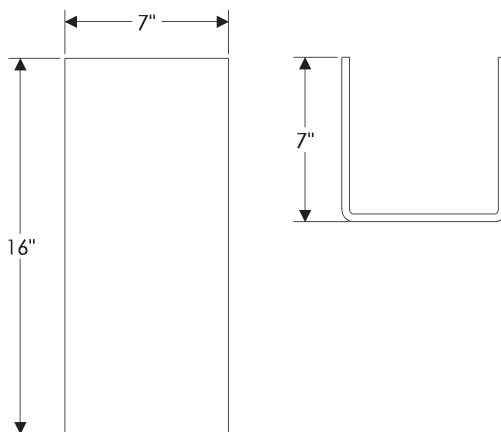
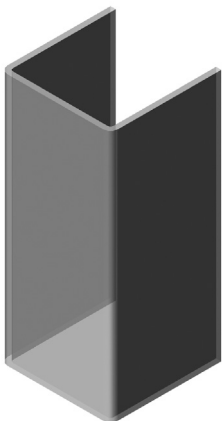

Square Slump 7
7" x 16" x 7" \$ 206.00 net

- All shades are hand-blown and hand-crafted glass. The size and surface finish may vary.
- All fixtures are provided with shades. These shades are listed for replacement only.

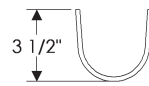
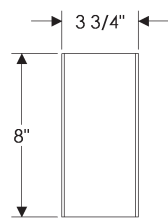

Curve Slump 3.5
 3 3/4" x 8" x 3 1/2" \$ 92.00 net

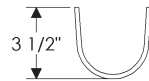
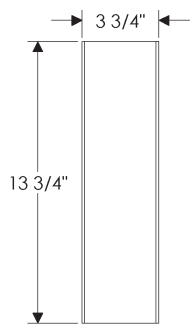

Curve Slump 4
 3 3/4" x 13 3/4" x 3 1/2" \$ 141.00 net

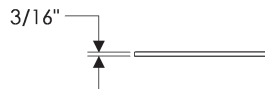
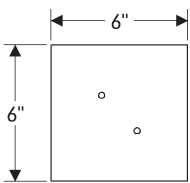

Shade 6
 6" x 6" x 3/16" \$ 55.00 net

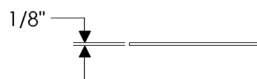
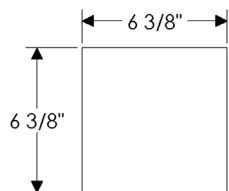

Flat 30
 6 3/8" x 6 3/8" x 1/8" \$ 18.00 net

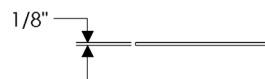
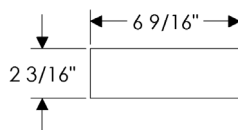

Flat 35
 6 9/16" x 2 3/16" x 1/8" \$ 9.00 net

- All shades are hand-blown and hand-crafted glass. The size and surface finish may vary.
- All fixtures are provided with shades. These shades are listed for replacement only.
- Shades Flat 20, Flat 40, and Corrugated Flat 20 require professional installation.

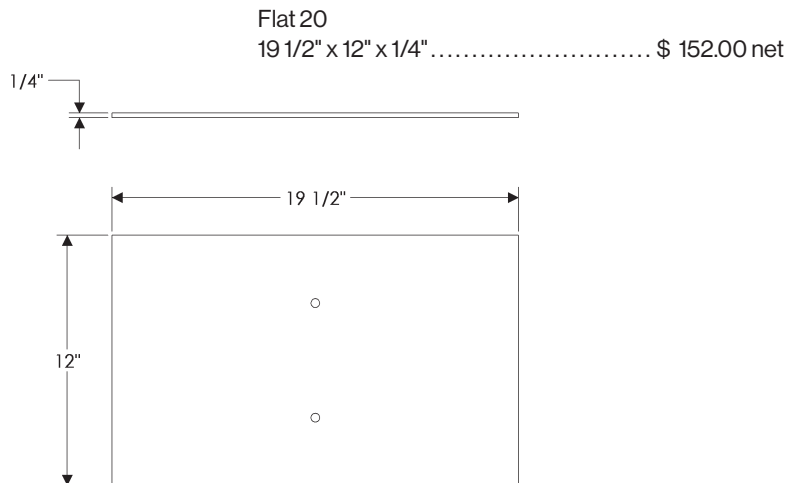
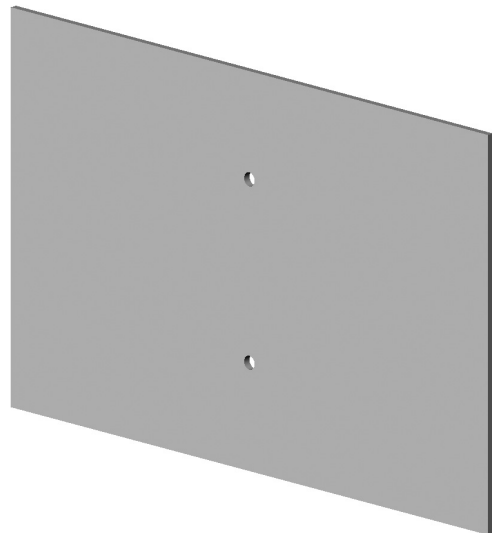
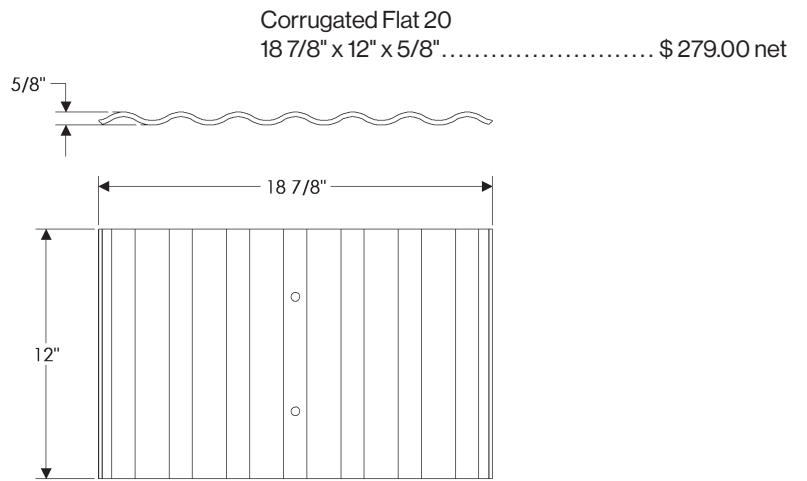
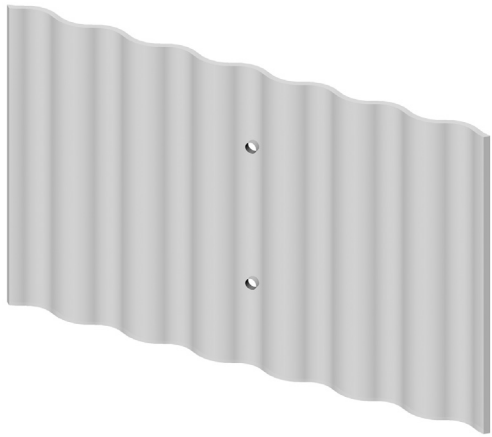

- All shades are hand-blown and hand-crafted glass. The size and surface finish may vary.
- All fixtures are provided with shades. These shades are listed for replacement only.
- Shades Flat 20, Flat 40, and Corrugated Flat 20 require professional installation.

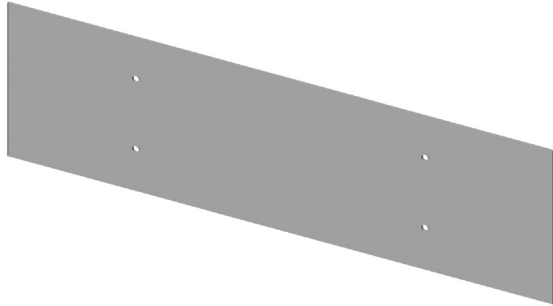

Flat 40
41 1/2" x 12" x 1/4" \$ 339.00 net

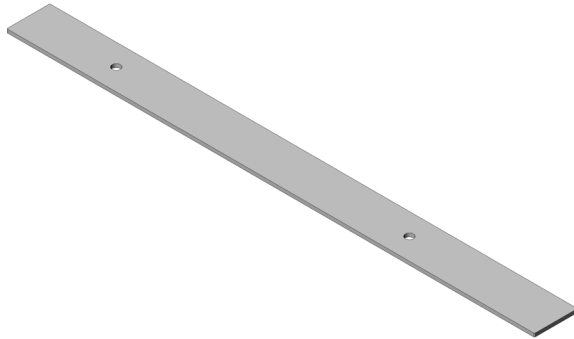
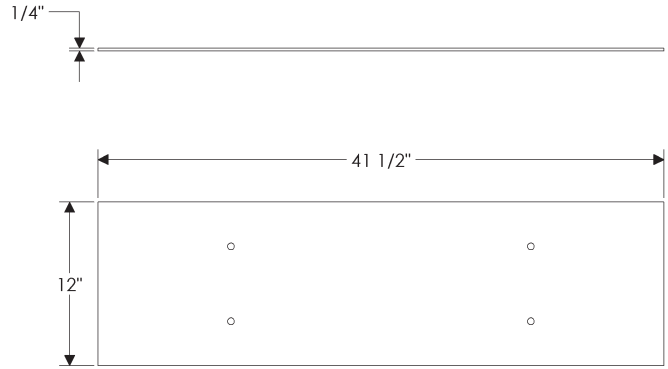

Flat 50
36" x 2 15/16" x 1/4" \$ 92.00 net

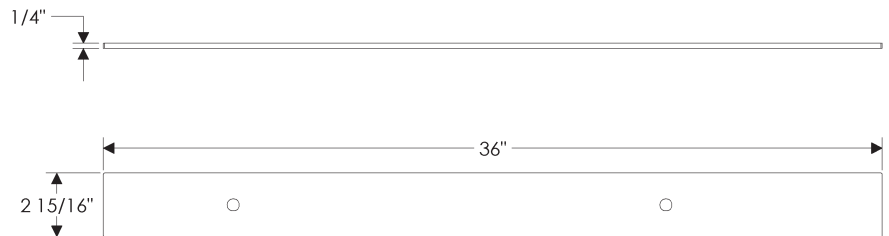

- All shades are hand-blown and hand-crafted glass. The size and surface finish may vary.
- All fixtures are provided with shades. These shades are listed for replacement only.
- Shades Plank 20 and Corrugated Plank 20 require professional installation.

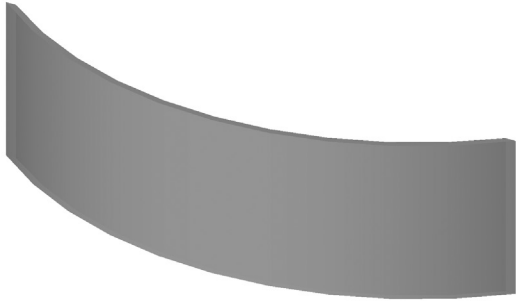

Plank 20
6 3/16" x 20" x 3 11/16" \$ 109.00 net

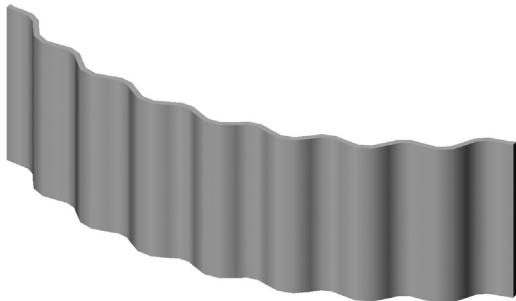
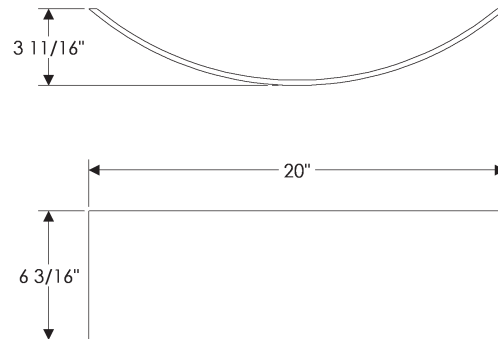

Corrugated Plank 20
6 3/16" x 19 7/8" x 3 7/8" \$ 134.00 net

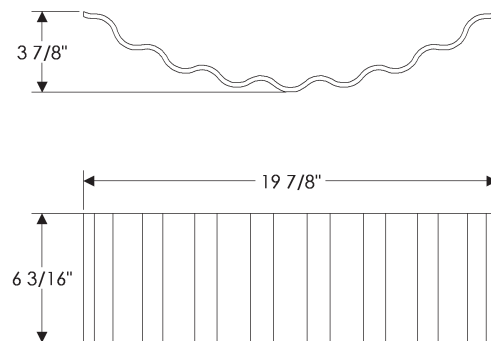

- All linen shades are 100% linen.
- Shades are available in the following colors: White, Flax, Taupe, or Black.
- Shades are available in the following styles: Cone and Drum.
- Linen shades included with appropriate fixtures. These shades are listed for replacement only.

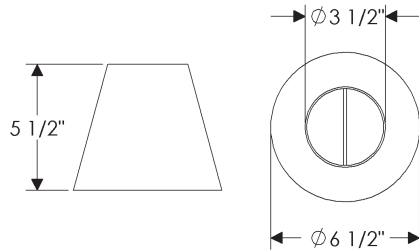
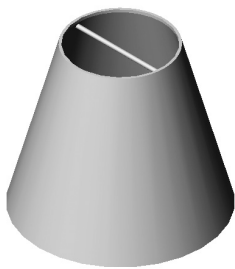

Cone 1
 6 1/2" diameter x 5 1/2" \$ 36.00 net
 • Available for C500 and WS500

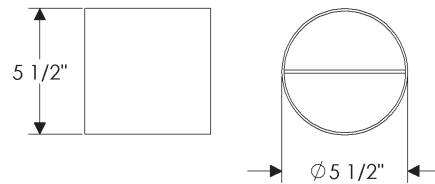
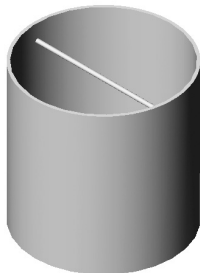

Drum 1
 5 1/2" diameter x 5 1/2" \$ 36.00 net
 • Available for C500 and WS500

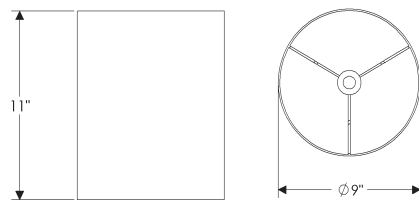

Drum 2
 9" diameter x 11" \$ 69.00 net
 • Available for PE532

- Specify metal, patina, and escutcheon.
- Light fixtures are shown with G4513 Rectangular escutcheon for illustration purposes only. See pages Tiii -Tiv for available escutcheon options.
- All LED lights are dimmable.
- The standard cable length for Cube chandeliers is 10'. Please specify if additional length is needed. Call RMH for pricing.
- Fixtures are UL rated for indoor and outdoor damp locations. A damp location is a protected area that is subject to moisture; such as under the eave of a roof.
- See page Tv-Tviii for electrical box location.
- Fixtures must be mounted independently of outlet box. Support blocking in ceiling is required.
- See page Ti for leather options. Bronze textures not available. Refer to website or brochure for leather details.

Chandelier

C400FB
(Flat Box)

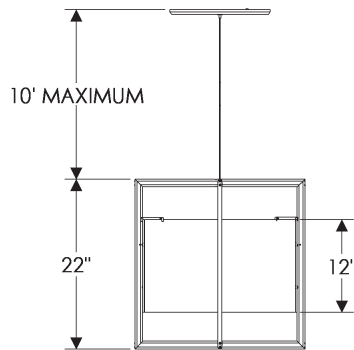
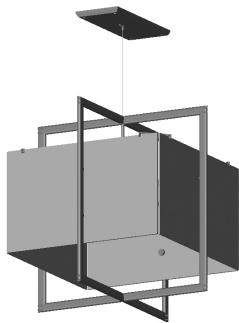

C400CB
(Corrugated Box)

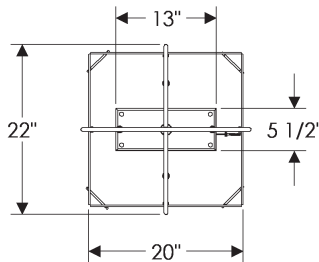
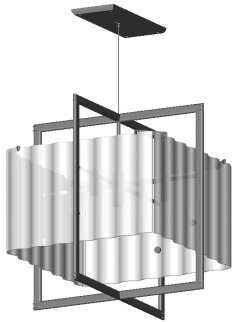

Cube Chandelier

- 10' Maximum cord length.
- 4 incandescent or compact fluorescent type B bulbs.
- 60 watts maximum ea.
- Bulbs not included.
- Price includes glass shade.
- * Designer escutcheon requires leather choice.



LED Cube Chandelier

- 10' Maximum cord length.
- Price includes LED lamp.
- Price includes glass shade.
- 120VAC, 60Hz
- 13.2 W, 2700K
- * Designer escutcheon requires leather choice.

Chandelier	Overall Width	Overall Depth	Overall Height	Shade Type	Wt. lbs.	Standard Escutcheon	Designer Escutcheon* (G153)
C400FB	22"	22"	22"	Flat 20	44.00	\$9,530.00	\$9,930.00
C400FB-LED	22"	22"	22"	Flat 20	44.00	\$9,862.00	\$10,262.00
C400CB	22"	22"	22"	Corrugated	44.00	\$9,530.00	\$9,930.00
C400CB-LED	22"	22"	22"	Corrugated	44.00	\$9,862.00	\$10,262.00

- Specify metal, patina, and escutcheon.
- Light fixtures are shown with E403 Square escutcheon for illustration purposes only. See pages Tiii -Tiv for available escutcheon options.
- All LED lights are dimmable.
- The standard length for Cube chandeliers is 10'. Please specify if additional length is needed. Call RMH for pricing.
- Fixtures are UL rated for indoor and outdoor damp locations. A damp location is a protected area that is subject to moisture; such as under the eave of a roof.
- See page Tv-Tviii for electrical box location.
- Fixtures must be mounted independently of outlet box. Support blocking in ceiling is required.
- See page Ti for leather options. Bronze textures not available. Refer to website or brochure for leather details.

Chandelier

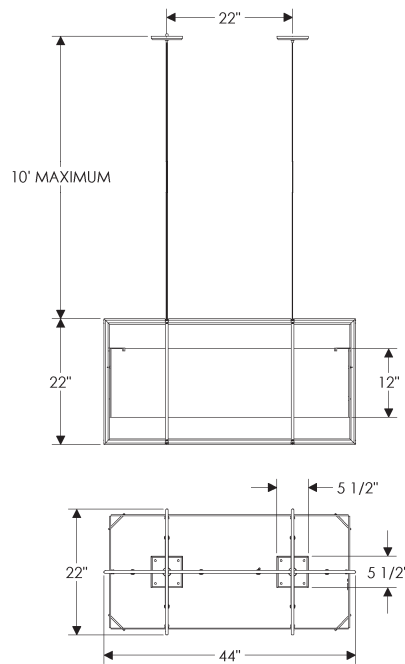
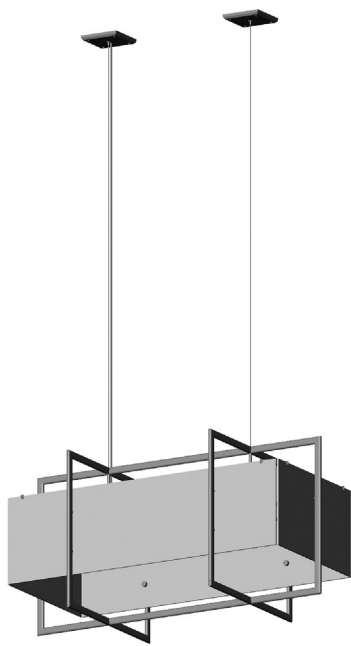

Double Cube Chandelier

- 10' Maximum cord length.
- 8 incandescent or compact fluorescent type B bulbs.
- 60 watts maximum ea.
- Bulbs not included.
- Price includes glass shades.
- * Designer escutcheon requires leather choice.



LED Double Cube Chandelier

- 10' Maximum cord length.
- Price includes LED lamp.
- Price includes glass shades.
- 120VAC, 60Hz
- 26.4 W, 2700K
- * Designer escutcheon requires leather choice.

Chandelier	Overall Width	Overall Depth	Overall Height	Shade Type	Wt. lbs.	Standard Escutcheon	Designer Escutcheon* (E155)
C405FB	44"	22"	22"	Flat 20 & Flat 40	85.00	\$16,214.00	\$16,868.00
C405FB-LED	44"	22"	22"	Flat 20 & Flat 40	85.00	\$16,940.00	\$17,594.00

- Specify metal, patina, and escutcheon.
- Light fixtures are shown with E419 Round escutcheon for illustration purposes only. See pages Tiii -Tiv for available escutcheon options.
- All LED lights are dimmable.
- The standard length is 10'. Please specify if additional length is needed. Call RMH for pricing.
- Fixture is not UL rated.
- See page Tv-Tviii for electrical box location.
- Fixtures must be mounted independently of outlet box. Support blocking in ceiling is required.
- See page Ti for leather options. Bronze textures not available. Refer to website or brochure for leather details.

Chandelier



LED Linear Chandelier

- 10' Maximum cord length.
 - Power supply included but not attached to fixture.
 - Provide remote location for included LED driver, approximately 3.5" x 3.5" x 11" air gap required.
 - LED lamp included.
 - 65 watts.
 - Price includes glass shades.
 - 120VAC, 60Hz
 - 65 W, 2600K
- * Designer escutcheon requires leather choice.

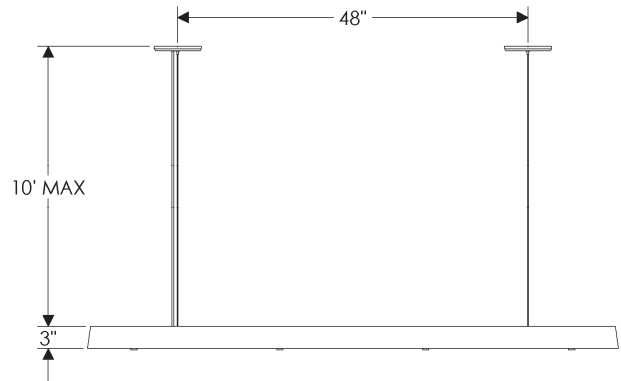

Chandelier	Overall Width	Overall Depth	Overall Height	Shade Type	Wt. lbs.	Standard Escutcheon	Designer Escutcheon* (E155)
C420-LED	72 3/4"	3 3/4"	3"	Flat 50	65.00	\$12,095.00	\$12,749.00

- Specify metal, patina, and escutcheon.
- Light fixtures are shown with G4513 Rectangular escutcheon for illustration purposes only. See pages Tiii -Tiv for available escutcheon options.
- All LED lights are dimmable.
- Specify fixture length. The maximum standard length for Cross Arm Chandelier is 8'. Please specify if additional length is needed. Call RMH for pricing.
- Fixtures are UL rated for indoor and outdoor damp locations. A damp location is a protected area that is subject to moisture; such as under the eave of a roof.
- See page Tv-Tviii for electrical box location.
- Fixtures must be mounted independently of outlet box. Support blocking in ceiling is required.
- See page Ti for leather options. Bronze textures not available. Refer to website or brochure for leather details.

Chandelier



C450
(Round Glass)

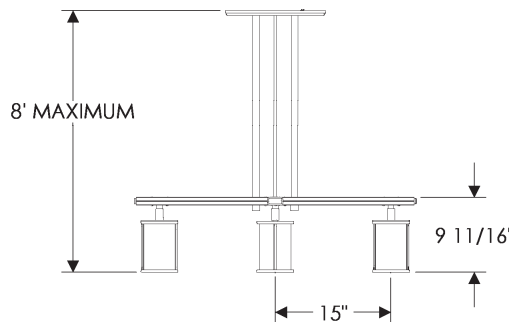

C455
(Square Glass)

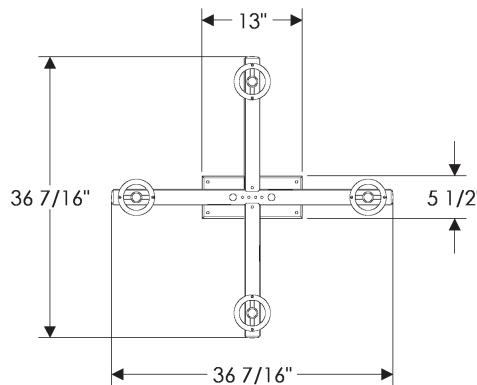

Cross Arm Chandelier

- 8' maximum length.
- 4 incandescent or compact fluorescent type A bulbs.
- 100 watts maximum ea.
- Bulbs not included.
- Price includes glass shade.
- * Designer escutcheon requires leather choice.



LED Cross Arm Chandelier

- 8' maximum length.
- Price includes LED lamp.
- Price includes glass shade.
- 120VAC, 60Hz
- 13.2 W, 2700K
- * Designer escutcheon requires leather choice.

Chandelier	Overall Width	Overall Depth	Overall Height	Shade Type	Wt. lbs.	Standard Escutcheon	Designer Escutcheon* (G153)
C450	36 7/16"	36 7/16"	9 11/16"	Globe 001	50.00	\$8,434.00	\$8,834.00
C450-LED	36 7/16"	36 7/16"	9 11/16"	Globe 001	50.00	\$8,767.00	\$9,167.00
C455	36 7/16"	36 7/16"	9 11/16"	Globe 004	50.00	\$8,434.00	\$8,834.00
C455-LED	36 7/16"	36 7/16"	9 11/16"	Globe 004	50.00	\$8,767.00	\$9,167.00

- Specify metal and patina.
- Light fixtures shown with E419 Round escutcheon for illustration purposes only. See pages Tiii -Tiv for available escutcheon options.
- Specify fixture lengths. The maximum standard length for the 5–Arm Chandelier is 77".
Please specify if additional length is needed. Call RMH for pricing.
- Fixtures are UL rated for indoor and outdoor damp locations. A damp location is a protected area that is subject to moisture; such as under the eave of a roof.
- See page Tv-Tviii for electrical box location.
- Fixtures must be mounted independently of outlet box. Support blocking in ceiling is required.

Chandelier

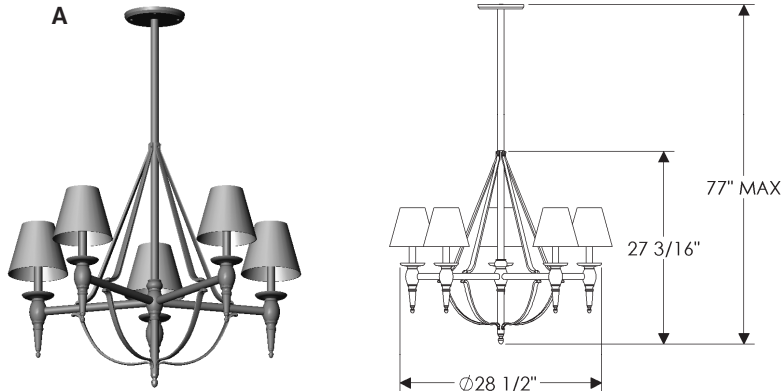

Towne 5–Arm Chandelier

- Price includes fabric shade.
- 5 incandescent or compact fluorescent type B bulbs.
- 60 watts maximum ea.
- Bulbs not included.
- Price includes fabric shade.

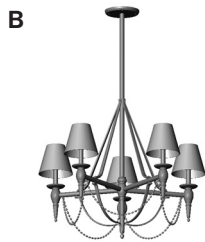

with crystals only

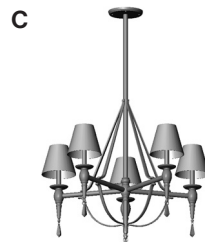

with prisms only

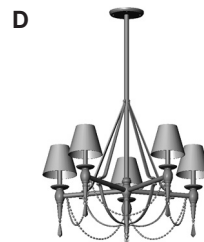

with crystals & prisms

SHADE OPTIONS



Cone 1

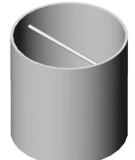

Drum 1

C500	Overall Width	Overall Depth	Overall Height	Shade Type	Wt. lbs.	Standard Escutcheon
Option A	28 1/2"	28 1/2"	27 3/16"	Cone 1 or Drum 1	46.00	\$11,622.00
Option B	28 1/2"	28 1/2"	27 3/16"	Cone 1 or Drum 1	46.00	\$12,251.00
Option C	28 1/2"	28 1/2"	27 3/16"	Cone 1 or Drum 1	46.00	\$12,336.00
Option D	28 1/2"	28 1/2"	27 3/16"	Cone 1 or Drum 1	46.00	\$12,965.00

- Specify metal and patina.
- Light fixtures shown with E419 Round escutcheon for illustration purposes only. See pages Tiii -Tiv for available escutcheon options.
- Specify fixture lengths. The maximum standard length for the 3–Arm Chandelier is 73".
Please specify if additional length is needed. Call RMH for pricing.
- Fixtures are UL rated for indoor and outdoor damp locations. A damp location is a protected area that is subject to moisture; such as under the eave of a roof.
- See page Tv-Tviii for electrical box location.
- Fixtures must be mounted independently of outlet box. Support blocking in ceiling is required.

Chandelier

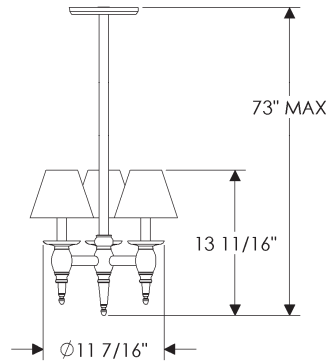

Towne 3–Arm Chandelier

- 3 incandescent or compact fluorescent type B bulbs.
- 60 watts maximum ea.
- Bulbs not included.
- Price includes fabric shade.

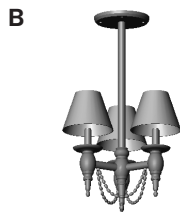

with crystals only



with prisms only



with crystals & prisms

SHADE OPTIONS



Cone 1

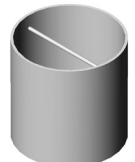

Drum 1

C525	Overall Width	Overall Depth	Overall Height	Shade Type	Wt. lbs.	Standard Escutcheon
Option A	11 7/16"	11 7/16"	13 11/16"	Cone 1 or Drum 1	33.00	\$5,739.00
Option B	11 7/16"	11 7/16"	13 11/16"	Cone 1 or Drum 1	33.00	\$6,132.00
Option C	11 7/16"	11 7/16"	13 11/16"	Cone 1 or Drum 1	33.00	\$6,167.00
Option D	11 7/16"	11 7/16"	13 11/16"	Cone 1 or Drum 1	33.00	\$6,561.00

- Specify metal, patina, and escutcheon.
- Light fixtures are shown with E403 Square escutcheon for illustration purposes only. See pages Tiii -Tiv for available escutcheon options.
- All LED lights are dimmable.
- The standard cable length for pendants is 10'. Please specify if additional length is needed. Call RMH for pricing.
- Fixtures are UL rated for indoor and outdoor damp locations. A damp location is a protected area that is subject to moisture; such as under the eave of a roof.
- See page Tv-Tviii for electrical box location.
- Fixtures must be mounted independently of outlet box. Support blocking in ceiling is required.
- See page Ti for leather options. Bronze textures not available. Refer to website or brochure for leather details.

Pendants

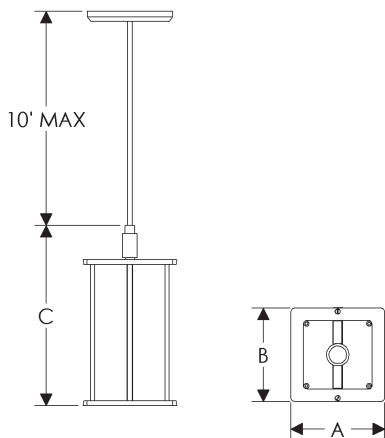

Pendant

- 10' Maximum cord length.
- incandescent type bulb.
- 100 watts maximum.
- Bulb not included.
- Price includes glass shade when applicable.
- E155 Square Designer Escutcheon requires leather choice.

LED Pendant

- 10' Maximum cord length.
- Price includes LED lamp.
- Price includes glass shade.
- 120VAC, 60Hz
- 3.3 W, 2700K
- E155 Square Designer Escutcheon requires leather choice.

Pendant	A Width	B Depth	C Height	Shade Type	Bulb Type	Wt. lbs.	Price	LED Price
PE455	5"	5"	8 11/16"	Globe 004	A	3.50	\$1,801.00	\$1,983.00
PE455 w/E155	5"	5"	8 11/16"	Globe 004	A	3.50	\$2,128.00	\$2,310.00
PE450	4 3/4"	4 3/4"	8 11/16"	Globe 001	A	3.50	\$1,801.00	\$1,983.00
PE450 w/E155	4 3/4"	4 3/4"	8 11/16"	Globe 001	A	3.50	\$2,128.00	\$2,310.00
PE465	6"	6"	11 1/2"	Globe 005	A	7.00	\$3,406.00	\$3,588.00
PE465 w/E155	6"	6"	11 1/2"	Globe 005	A	7.00	\$3,733.00	\$3,915.00

- Specify metal, patina, and escutcheon.
- Light fixtures are shown with E403 Square escutcheon for illustration purposes only. See pages Tiii -Tiv for available escutcheon options.
- All LED lights are dimmable.
- The standard cable length for pendants is 10'. Please specify if additional length is needed. Call RMH for pricing.
- Fixtures are UL rated for indoor and outdoor damp locations. A damp location is a protected area that is subject to moisture; such as under the eave of a roof.
- See page Tv-Tviii for electrical box location.
- Fixtures must be mounted independently of outlet box. Support blocking in ceiling is required.
- See page Ti for leather options. Bronze textures not available. Refer to website or brochure for leather details.

Pendants

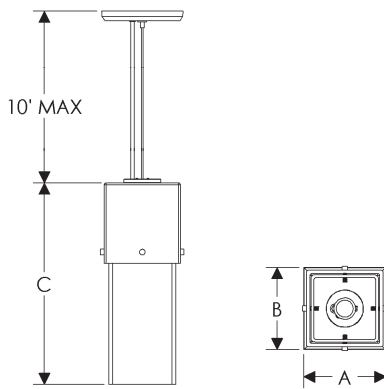
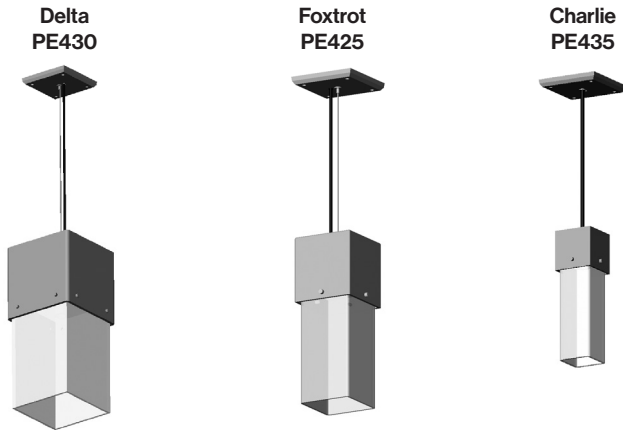

Pendant

- 10' Maximum cord length.
- incandescent type bulb.
- 100 watts maximum.
- Bulb not included.
- Price includes glass shade when applicable.
- E155 Square Designer Escutcheon requires leather choice.

LED Pendant

- 10' Maximum cord length.
- Price includes LED lamp.
- Price includes glass shade.
- 120VAC, 60Hz
- 3.3 W, 2700K
- E155 Square Designer Escutcheon requires leather choice.

Pendant	A Width	B Depth	C Height	Shade Type	Bulb Type	Wt. lbs.	Price	LED Price
PE430	8"	8"	18"	Shade 10	A	40.00	\$4,417.00	\$4,599.00
PE430 w/E155	8"	8"	18"	Shade 10	A	40.00	\$4,744.00	\$4,926.00
PE425	5 1/8"	5 1/8"	13 1/4"	Globe 002	A	15.00	\$2,471.00	\$2,653.00
PE425 w/E155	5 1/8"	5 1/8"	13 1/4"	Globe 002	A	15.00	\$2,798.00	\$2,980.00
PE435	3 1/2"	3 1/2"	11 1/2"	S Tube 003	A or T	5.00	\$1,755.00	\$1,937.00
PE435 w/E155	3 1/2"	3 1/2"	11 1/2"	S Tube 003	A or T	5.00	\$2,082.00	\$2,264.00

- Specify metal, patina, and escutcheon.
- Light fixtures are shown with E403 Square escutcheon for illustration purposes only. See pages Tiii -Tiv for available escutcheon options.
- The standard cable length for pendants is 10'. Please specify if additional length is needed. Call RMH for pricing.
- Fixtures are UL rated for indoor and outdoor damp locations. A damp location is a protected area that is subject to moisture; such as under the eave of a roof.
- See page Tv-Tviii for electrical box location.
- Fixtures must be mounted independently of outlet box. Support blocking in ceiling is required.
- See page Ti for leather options. Bronze textures not available. Refer to website or brochure for leather details.

Pendants

**Luna
PE490**



**Torch
PE625-LED**

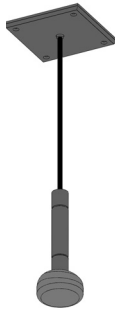

**Icicle
PE627**

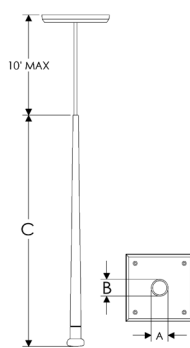
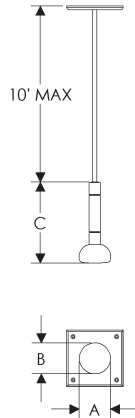
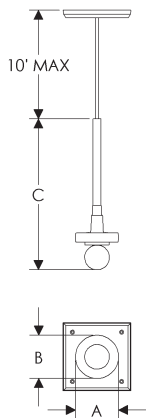

Pendant

- incandescent type bulb.
- 100 watts maximum.
- Bulb not included.
- Price includes glass shade when applicable.
- E155 Square Designer Escutcheon requires leather choice.

LED Pendant

- Price includes LED lamp.
- Price includes glass shade.
- 120VAC, 60Hz
- 4 W, 3000K
- E155 Square Designer Escutcheon requires leather choice.
- PE625-LED And PE627 are not dimmable.

Pendant	A Width	B Depth	C Height	Shade Type	Bulb Type	Wt. lbs.	Price	LED Price
PE490	3 1/2"	3 1/2"	12"	-	B	4.50	\$1,474.00	N/A
PE490 w/E155	3 1/2"	3 1/2"	12"	-	B	4.50	\$1,801.00	N/A
PE625	2 1/2"	2 1/2"	6 9/16"	-	N/A	3.50	N/A	\$1,375.00
PE625 w/E155	2 1/2"	2 1/2"	6 9/16"	-	N/A	3.50	N/A	\$1,702.00
PE627	1 3/8"	1 3/8"	18 7/8"	-	N/A	2.00	N/A	\$1,470.00
PE627 w/E155	1 3/8"	1 3/8"	18 7/8"	-	N/A	2.00	N/A	\$1,797.00

- Specify metal, patina, and escutcheon.
- Light fixtures are shown with E419 Round and E280 Metro escutcheons for illustration purposes only. See pages Tiii -Tiv for available escutcheon options.
- All LED lights are dimmable.
- Fixtures are UL rated for indoor and outdoor damp locations. A damp location is a protected area that is subject to moisture; such as under the eave of a roof.
- See page Tv-Tviii for electrical box location.
- Fixtures must be mounted independently of outlet box. Support blocking in ceiling is required.
- See page Ti for leather options. Bronze textures not available. Refer to website or brochure for leather details.

Pendants

**Cargo
PE530**



**Madison
PE532**

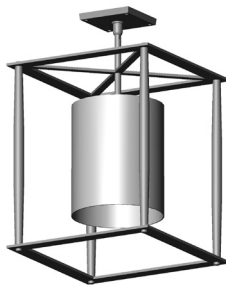

Pendant

- incandescent type bulb.
- 100 watts maximum.
- Bulb not included.
- Price includes glass shade when applicable.

LED Pendant

- Price includes LED lamp.
- Price includes fabric shade.
- 120VAC, 60Hz
- 13.2 W, 2700K
- E155 Square Designer Escutcheon requires leather choice.

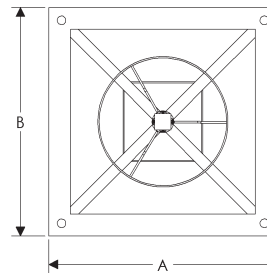
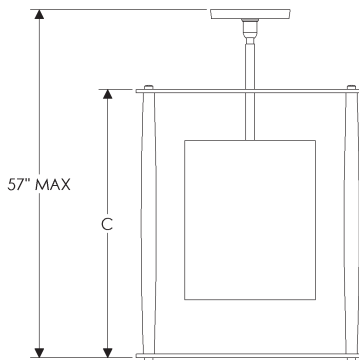
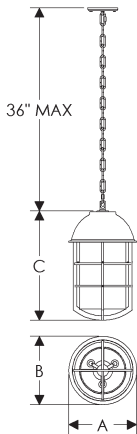

Pendant	A Width	B Depth	C Height	Shade Type	Bulb Type	Wt. lbs.	Price	LED Price
PE530	14 1/2"	14 1/2"	23 1/2"	Globe 010	A	85.00	\$16,605.00	N/A
PE532	15 3/4"	15 3/4"	18 1/2"	Drum 2	N/A	38.00	N/A	\$10,556.00
PE532 w/E155	15 3/4"	15 3/4"	18 1/2"	Drum 2	N/A	38.00	N/A	\$10,883.00

- Specify metal, patina, and escutcheon.
- Light fixtures are shown with E419 Round escutcheons for illustration purposes only. See pages Tiii -Tiv for available escutcheon options.
- All LED lights are dimmable.
- Fixtures are UL rated for indoor and outdoor damp locations. A damp location is a protected area that is subject to moisture; such as under the eave of a roof.
- See page Tv-Tviii for electrical box location.
- Fixtures must be mounted independently of outlet box. Support blocking in ceiling is required.
- See page Ti for leather options. Bronze textures not available. Refer to website or brochure for leather details.

Pendants

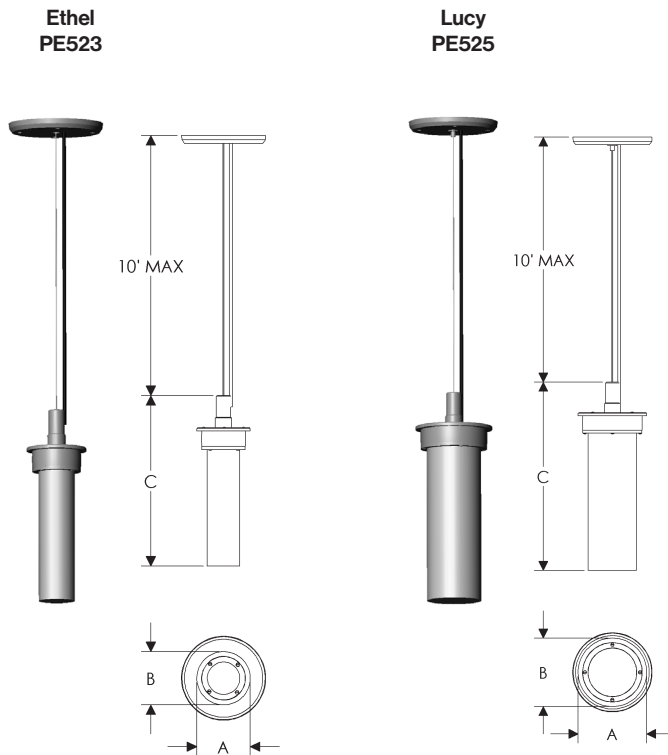

LED Pendant

- Price includes LED lamp.
- Price includes fabric shade.
- 120VAC, 60Hz
- 13.2 W, 2700K
- E155 Square Designer Escutcheon requires leather choice.

Pendant	A Width	B Depth	C Height	Shade Type	Wt. lbs.	LED Price
PE525	5 5/8"	5 5/8"	16 3/16"	GLOBE 006	20.5	\$5,450.00
PE525 W/E155	5 5/8"	5 5/8"	16 3/16"	GLOBE 006	20.5	\$5,777.00
PE525	5 5/8"	5 5/8"	11 3/16"	GLOBE 007	15.25	\$5,450.00
PE525 W/E155	5 5/8"	5 5/8"	11 3/16"	GLOBE 007	15.25	\$5,777.00
PE523	4 1/8"	4 1/8"	13 3/16"	GLOBE008	9.6	\$3,915.00
PE523 / E155	4 1/8"	4 1/8"	13 3/16"	GLOBE008	9.6	\$4,242.00
PE523	4 1/8"	4 1/8"	10 5/8"	GLOBE009	8.6	\$3,915.00
PE523 / E155	4 1/8"	4 1/8"	10 5/8"	GLOBE009	8.6	\$4,242.00

- Specify metal and patina.
- All LED lights are dimmable.
- Fixtures are UL rated for indoor and outdoor damp locations. A damp location is a protected area that is subject to moisture; such as under the eave of a roof.
- See page Tv-Tviii for electrical box location.
- Fixtures must be mounted independently of outlet box. Support blocking in ceiling is required.

Ceiling Light CF485-LED

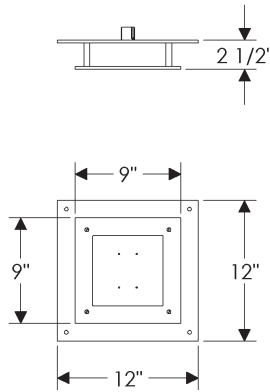
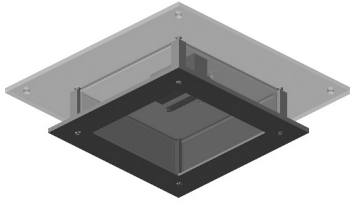

Crosby Ceiling Light

- Price includes LED lamp.
- Price includes glass shades.
- 120VAC, 60Hz
- 6.6 W, 2700K

Ceiling Light	Overall Width	Overall Depth	Overall Height	Shade Type	Bulb Type	Wt. lbs.	Price
CF485-LED	12"	12"	2 1/2"	Flat 30 & Flat 35	-	18.00	\$2,272.00

- Specify metal and patina.
- Fixtures are UL rated for indoor and outdoor damp locations. A damp location is a protected area that is subject to moisture; such as under the eave of a roof.
- See page Tv-Tviii for electrical box location.
- Fixtures must be mounted independently of outlet box. Support blocking in wall is recommended.
- See page Ti for leather options. Bronze textures not available. Refer to website or brochure for leather details.

Vanity

V440
w/Flat Glass



V445
w/Corrugated Glass

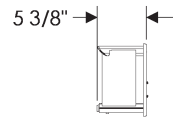
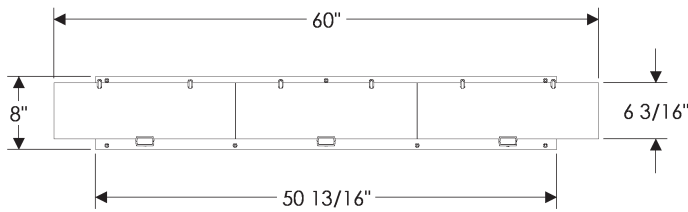
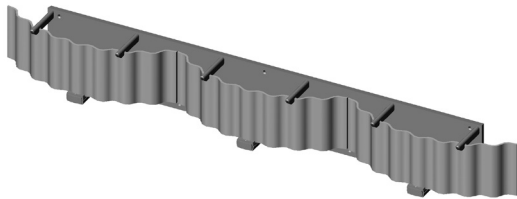

Triple Plank

- 3 incandescent or compact fluorescent type A bulbs.
- 100 watts maximum ea.
- Bulbs not included.
- Price includes glass shades.



LED Triple Plank

- Price includes LED lamp.
- Price includes glass shades.
- 120VAC, 60Hz
- 10 W, 2700K

Vanity	Overall Width	Overall Projection	Overall Height	Shade Type	Bulb Type	Wt. lbs.	Price
V440	60"	5 3/8"	8"	Plank 20	A	60.00	\$6,728.00
V440-LED	60"	5 3/8"	8"	Plank 20	-	60.00	\$7,018.00
V445	60"	5 1/4"	8"	Corrugated Plank 20	A	60.00	\$6,728.00
V445-LED	60"	5 1/4"	8"	Corrugated Plank 20	-	60.00	\$7,018.00

- Specify metal, patina, and escutcheon.
- Light fixtures are shown with E403 Square escutcheon for illustration purposes only. See pages Tiii -Tiv for available escutcheon options.
- All LED lights are dimmable.
- Fixtures are UL rated for indoor and outdoor damp locations. A damp location is a protected area that is subject to moisture; such as under the eave of a roof.
- See page Tix-Txiv for electrical box location.
- Fixtures must be mounted independently of outlet box. Support blocking in wall is recommended.
- See page Ti for leather options. Bronze textures not available. Refer to website or brochure for leather details.

Vanity V450

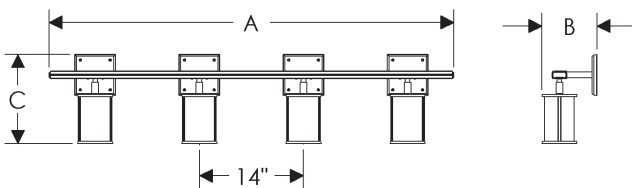
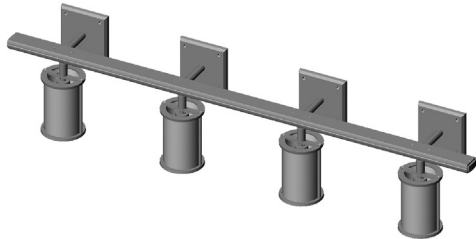

Lantern Vanity

- incandescent or compact fluorescent type A bulbs.
- 100 watts maximum ea.
- Bulbs not included.
- Price includes glass shades.
- * Designer escutcheon (E155) requires leather choice.



LED Lantern Vanity

- Price includes LED lamp.
- Price includes glass shade.
- 120VAC, 60Hz
- 13 W, 2700K
- * Designer escutcheon (E155) requires leather choice.

Vanity	A Length	B Projection	C Height	# of Globes	Shade Type	Wt. lbs.	Standard Escutcheon	Designer Escutcheon*
V450-26	26 7/16"	7 3/8"	11 15/16"	2	Globe 001	21.00	\$3,467.00	\$4,121.00
V450-26-LED	26 7/16"	7 3/8"	11 15/16"	2	Globe 001	21.00	\$3,678.00	\$4,332.00
V450-40	40 7/16"	7 3/8"	11 15/16"	3	Globe 001	27.00	\$5,029.00	\$6,010.00
V450-40-LED	40 7/16"	7 3/8"	11 15/16"	3	Globe 001	27.00	\$5,319.00	\$6,300.00
V450-54	54 7/16"	7 3/8"	11 15/16"	4	Globe 001	34.00	\$6,510.00	\$7,818.00
V450-54-LED	54 7/16"	7 3/8"	11 15/16"	4	Globe 001	34.00	\$6,844.00	\$8,152.00
V450-68	68 7/16"	7 3/8"	11 15/16"	5	Globe 001	40.00	\$8,180.00	\$9,815.00
V450-68-LED	68 7/16"	7 3/8"	11 15/16"	5	Globe 001	40.00	\$8,591.00	\$10,226.00
V450-82	82 7/16"	7 3/8"	11 15/16"	6	Globe 001	45.00	\$9,721.00	\$11,683.00
V450-82-LED	82 7/16"	7 3/8"	11 15/16"	6	Globe 001	45.00	\$10,174.00	\$12,136.00
V450-94	94 7/16"	7 3/8"	11 15/16"	7	Globe 001	50.00	\$11,284.00	\$13,573.00
V450-94-LED	94 7/16"	7 3/8"	11 15/16"	7	Globe 001	50.00	\$11,817.00	\$14,106.00

- Specify metal, patina, and escutcheon.
- Light fixtures are shown with E403 Square escutcheon for illustration purposes only. See pages Tiii -Tiv for available escutcheon options.
- All LED lights are dimmable.
- Fixtures are UL rated for indoor and outdoor damp locations. A damp location is a protected area that is subject to moisture; such as under the eave of a roof.
- See page Tix-Txiv for electrical box location.
- Fixtures must be mounted independently of outlet box. Support blocking in wall is recommended.
- See page Ti for leather options. Bronze textures not available. Refer to website or brochure for leather details.

Vanity V455

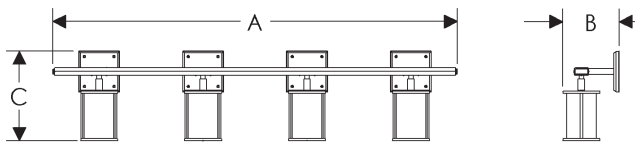
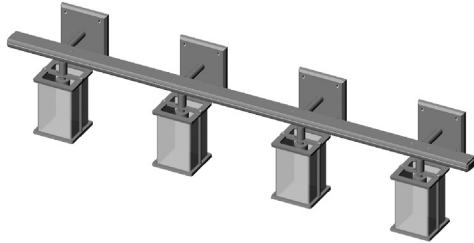

Lantern Vanity

- incandescent or compact fluorescent type A bulbs.
- 100 watts maximum ea.
- Bulbs not included.
- Price includes glass shades.
- * Designer escutcheon (E155) requires leather choice.



LED Lantern Vanity

- Price includes LED lamp.
- Price includes glass shade.
- 120VAC, 60Hz
- 13 W, 2700K
- * Designer escutcheon (E155) requires leather choice.

Vanity	A Length	B Projection	C Height	# of Globes	Shade Type	Wt. lbs.	Standard Escutcheon	Designer Escutcheon*
V455-26	26 7/16"	7 3/8"	11 15/16"	2	Globe 004	21.00	\$3,467.00	\$4,121.00
V455-26-LED	26 7/16"	7 3/8"	11 15/16"	2	Globe 004	21.00	\$3,678.00	\$4,332.00
V455-40	40 7/16"	7 3/8"	11 15/16"	3	Globe 004	27.00	\$5,029.00	\$6,010.00
V455-40-LED	40 7/16"	7 3/8"	11 15/16"	3	Globe 004	27.00	\$5,319.00	\$6,300.00
V455-54	54 7/16"	7 3/8"	11 15/16"	4	Globe 004	34.00	\$6,510.00	\$7,818.00
V455-54-LED	54 7/16"	7 3/8"	11 15/16"	4	Globe 004	34.00	\$6,844.00	\$8,152.00
V455-68	68 7/16"	7 3/8"	11 15/16"	5	Globe 004	40.00	\$8,180.00	\$9,815.00
V455-68-LED	68 7/16"	7 3/8"	11 15/16"	5	Globe 004	40.00	\$8,591.00	\$10,226.00
V455-82	82 7/16"	7 3/8"	11 15/16"	6	Globe 004	45.00	\$9,721.00	\$11,683.00
V455-82-LED	82 7/16"	7 3/8"	11 15/16"	6	Globe 004	45.00	\$10,174.00	\$12,136.00
V455-94	94 7/16"	7 3/8"	11 15/16"	7	Globe 004	50.00	\$11,284.00	\$13,573.00
V455-94-LED	94 7/16"	7 3/8"	11 15/16"	7	Globe 004	50.00	\$11,817.00	\$14,106.00

- Specify metal, patina, and escutcheon.
- See pages Tiii -Tiv for available escutcheon options.
- All LED lights are dimmable.
- Fixtures are UL listed for indoor and outdoor damp locations and wet locations. A damp location is a protected area that is subject to moisture; such as under the eave of a roof.
- See page Tv-Tviii for electrical box location.
- Fixtures must be mounted independently of outlet box. Support blocking in wall is recommended.
- See page Ti for leather options. Bronze textures not available. Refer to website or brochure for leather details.

Wall Sconce WS400

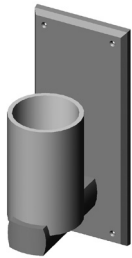

w/G4513

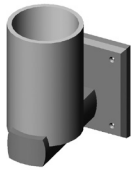

w/E403

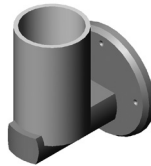

w/E419

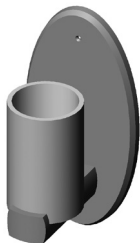

w/E560

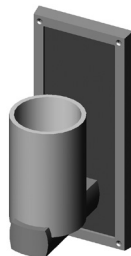

w/G153*

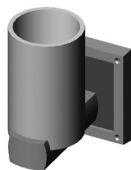

w/E155*

Post Sconce

- 1 incandescent or compact fluorescent type A bulb.
- 100 watts maximum.
- Bulb not included.
- Price includes glass shade (Globe 001).
- Available for wet locations (Globe 001-W).
- * Designer escutcheon requires leather choice.



LED Post Sconce

- Price includes LED lamp.
- Price includes glass shade (Globe 001).
- Available for wet locations (Globe 001-W).
- 120VAC, 60Hz
- 3.3 W, 2700K
- * Designer escutcheon requires leather choice.

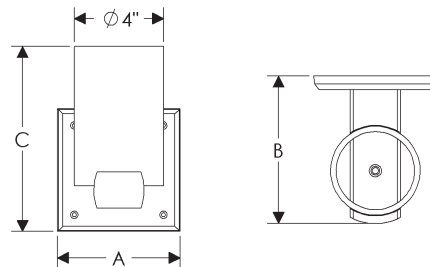

WS400	A Width	B Projecton	C Height	Shade Type	Bulb Type	Wt. lbs.	Price	LED Price
w/G4513	5 1/2"	6 5/8"	13"	Globe 001	A	11.00	\$1,809.00	\$1,991.00
w/E403	5 1/2"	6 5/8"	8 5/16"	Globe 001	A	10.00	\$1,809.00	\$1,991.00
w/E419	6 1/2"	6 5/8"	8 5/8"	Globe 001	A	10.00	\$1,809.00	\$1,991.00
w/E560	6 1/2"	6 5/8"	13"	Globe 001	A	11.00	\$1,809.00	\$1,991.00
w/G153*	5 1/2"	6 5/8"	13"	Globe 001	A	11.00	\$2,209.00	\$2,391.00
w/E155*	5 1/2"	6 5/8"	8 5/16"	Globe 001	A	10.00	\$2,136.00	\$2,318.00

- Specify metal, patina, and escutcheon.
- See pages Tiii -Tiv for available escutcheon options.
- All LED lights are dimmable.
- Fixtures are UL listed for indoor and outdoor damp locations and wet locations. A damp location is a protected area that is subject to moisture; such as under the eave of a roof.
- See page Tv-Tviii for electrical box location.
- Fixtures must be mounted independently of outlet box. Support blocking in wall is recommended.
- See page Ti for leather options. Bronze textures not available. Refer to website or brochure for leather details.

Wall Sconce WS405

Up-Light Orientation (Damp and Wet Location)



w/G4513



w/E403



w/E419

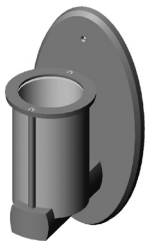

w/E560

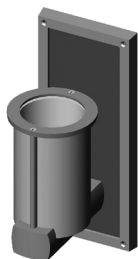

w/G153*

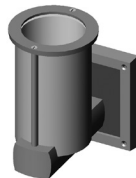

w/E155*

Down-Light Orientation (Damp Location Only)



Post-Ring Sconce

- 1 incandescent or compact fluorescent type A bulb.
- 100 watts maximum.
- Bulb not included.
- Price includes glass shade (Globe 001).
- Available for wet locations (Globe 001-W).
- * Designer escutcheon requires leather choice.



LED Post-Ring Sconce

- Price includes LED lamp.
- Price includes glass shade (Globe 001).
- Available for wet locations (Globe 001-W).
- 120VAC, 60Hz
- 3.3 W, 2700K
- * Designer escutcheon requires leather choice.

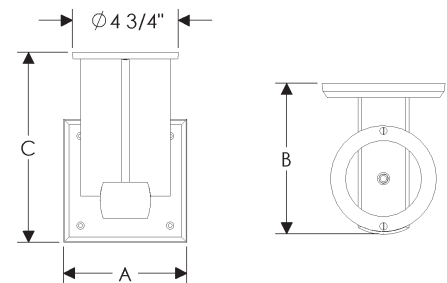

WS405	A Width	B Projecton	C Height	Shade Type	Bulb Type	Wt. lbs.	Price	LED Price
w/G4513	5 1/2"	6 7/8"	13"	Globe 001	A	11.00	\$2,004.00	\$2,186.00
w/E403	5 1/2"	6 7/8"	8 5/8"	Globe 001	A	10.00	\$2,004.00	\$2,186.00
w/E419	6 1/2"	6 7/8"	9 1/8"	Globe 001	A	10.00	\$2,004.00	\$2,186.00
w/E560	6 1/2"	6 7/8"	13"	Globe 001	A	11.00	\$2,004.00	\$2,186.00
w/G153*	5 1/2"	6 7/8"	13"	Globe 001	A	11.00	\$2,404.00	\$2,586.00
w/E155*	5 1/2"	6 7/8"	8 5/8"	Globe 001	A	10.00	\$2,331.00	\$2,513.00

- Specify metal, patina, and escutcheon.
- See pages Tiii -Tiv for available escutcheon options.
- All LED lights are dimmable.
- Fixtures are UL listed for indoor and outdoor damp locations and wet locations. A damp location is a protected area that is subject to moisture; such as under the eave of a roof.
- See page Tv-Tviii for electrical box location.
- Fixtures must be mounted independently of outlet box. Support blocking in wall is recommended.
- See page Ti for leather options. Bronze textures not available. Refer to website or brochure for leather details.

Wall Sconce WS410

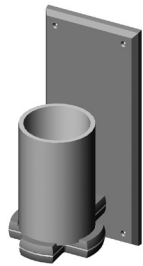

w/G4513

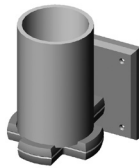

w/E403



w/E419

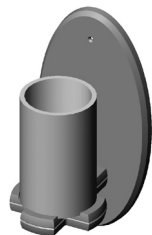

w/E560

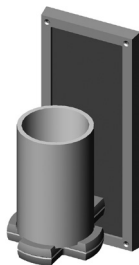

w/G153*

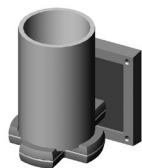

w/E155*

Truss Sconce

- 1 incandescent or compact fluorescent type A bulb.
- 100 watts maximum.
- Bulb not included.
- Price includes glass shade (Globe 001).
- Available for wet locations (Globe 001-W).
- * Designer escutcheon requires leather choice.



LED Truss Sconce

- Price includes LED lamp.
- Price includes glass shade (Globe 001).
- Available for wet locations (Globe 001-W).
- 120VAC, 60Hz
- 3.3 W, 2700K
- * Designer escutcheon requires leather choice.

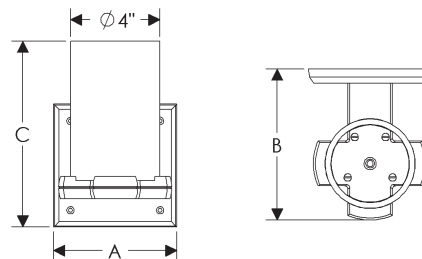

WS410	A Width	B Projecton	C Height	Shade Type	Bulb Type	Wt. lbs.	Price	LED Price
w/G4513	5 1/2"	6 3/4"	13"	Globe 001	A	11.00	\$1,852.00	\$2,034.00
w/E403	5 1/2"	6 3/4"	8 5/16"	Globe 001	A	10.00	\$1,852.00	\$2,034.00
w/E419	6 1/2"	6 3/4"	8 13/16"	Globe 001	A	10.00	\$1,852.00	\$2,034.00
w/E560	6 1/2"	6 3/4"	13"	Globe 001	A	11.00	\$1,852.00	\$2,034.00
w/G153*	5 1/2"	6 3/4"	13"	Globe 001	A	11.00	\$2,252.00	\$2,434.00
w/E155*	5 1/2"	6 3/4"	8 5/16"	Globe 001	A	10.00	\$2,179.00	\$2,361.00

- Specify metal, patina, and escutcheon.
- See pages Tiii -Tiv for available escutcheon options.
- All LED lights are dimmable.
- Fixtures are UL listed for indoor and outdoor damp locations and wet locations. A damp location is a protected area that is subject to moisture; such as under the eave of a roof.
- See page Tv-Tviii for electrical box location.
- Fixtures must be mounted independently of outlet box. Support blocking in wall is recommended.
- See page Ti for leather options. Bronze textures not available. Refer to website or brochure for leather details.

Wall Sconce WS415

Up-Light Orientation (Damp and Wet Location)



w/G4513



w/E403



w/E419



w/E560



w/G153*



w/E155*

Down-Light Orientation (Damp Location Only)



Truss-Ring Sconce

- 1 incandescent or compact fluorescent type A bulb.
- 100 watts maximum.
- Bulb not included.
- Price includes glass shade (Globe 001).
- Available for wet locations (Globe 001-W).
- * Designer escutcheon requires leather choice.



LED Truss-Ring Sconce

- Price includes LED lamp.
- Price includes glass shade (Globe 001).
- Available for wet locations (Globe 001-W).
- 120VAC, 60Hz
- 3.3 W, 2700K
- * Designer escutcheon requires leather choice.

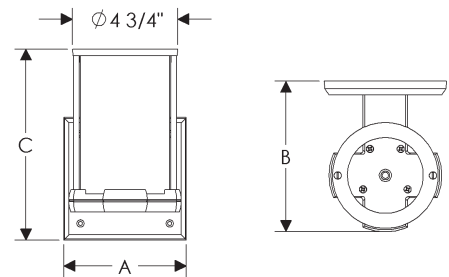

WS415	A Width	B Projecton	C Height	Shade Type	Bulb Type	Wt. lbs.	Price	LED Price
w/G4513	5 1/2"	6 3/4"	13"	Globe 001	A	11.00	\$2,052.00	\$2,234.00
w/E403	5 1/2"	6 3/4"	8 9/16"	Globe 001	A	10.00	\$2,052.00	\$2,234.00
w/E419	6 1/2"	6 3/4"	9 1/16"	Globe 001	A	10.00	\$2,052.00	\$2,234.00
w/E560	6 1/2"	6 3/4"	13"	Globe 001	A	11.00	\$2,052.00	\$2,234.00
w/G153*	5 1/2"	6 3/4"	13"	Globe 001	A	11.00	\$2,452.00	\$2,634.00
w/E155*	5 1/2"	6 3/4"	8 9/16"	Globe 001	A	10.00	\$2,379.00	\$2,561.00

- Specify metal, patina, and escutcheon.
- See pages Tiii -Tiv for available escutcheon options.
- All LED lights are dimmable.
- Fixtures are UL listed for indoor and outdoor damp locations and wet locations. A damp location is a protected area that is subject to moisture; such as under the eave of a roof.
- See page Tv-Tviii for electrical box location.
- Fixtures must be mounted independently of outlet box. Support blocking in wall is recommended.
- See page Ti for leather options. Bronze textures not available. Refer to website or brochure for leather details.

Wall Sconce WS416

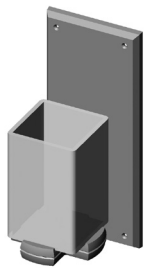

w/G4513

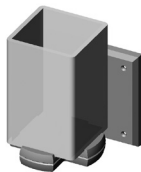

w/E403



w/E419

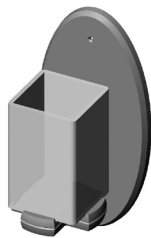

w/E560

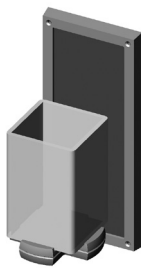

w/G153*

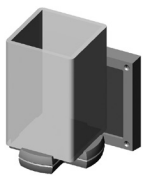

w/E155*

Truss Sconce

- 1 incandescent or compact fluorescent type A bulb.
- 100 watts maximum.
- Bulb not included.
- Price includes glass shade (Globe 004).
- Available for wet locations (Globe 004-W).
- * Designer escutcheon requires leather choice.



LED Truss Sconce

- Price includes LED lamp.
- Price includes glass shade (Globe 004).
- Available for wet locations (Globe 004-W).
- 120VAC, 60Hz
- 3.3 W, 2700K
- * Designer escutcheon requires leather choice.

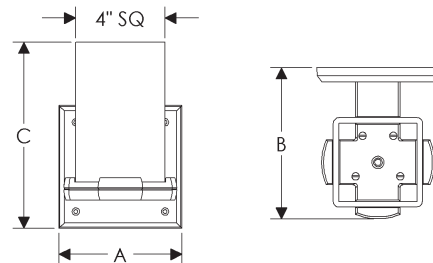

WS416	A Width	B Projecton	C Height	Shade Type	Bulb Type	Wt. lbs.	Price	LED Price
w/G4513	5 1/2"	6 3/4"	13"	Globe 004	A	11.00	\$1,852.00	\$2,034.00
w/E403	5 1/2"	6 3/4"	8 5/16"	Globe 004	A	10.00	\$1,852.00	\$2,034.00
w/E419	6 1/2"	6 3/4"	8 13/16"	Globe 004	A	10.00	\$1,852.00	\$2,034.00
w/E560	6 1/2"	6 3/4"	13"	Globe 004	A	11.00	\$1,852.00	\$2,034.00
w/G153*	5 1/2"	6 3/4"	13"	Globe 004	A	11.00	\$2,252.00	\$2,434.00
w/E155*	5 1/2"	6 3/4"	8 5/16"	Globe 004	A	10.00	\$2,179.00	\$2,361.00

- Specify metal, patina, and escutcheon.
- See pages Tiii -Tiv for available escutcheon options.
- All LED lights are dimmable.
- Fixtures are UL listed for indoor and outdoor damp locations and wet locations. A damp location is a protected area that is subject to moisture; such as under the eave of a roof.
- See page Tv-Tviii for electrical box location.
- Fixtures must be mounted independently of outlet box. Support blocking in wall is recommended.
- See page Ti for leather options. Bronze textures not available. Refer to website or brochure for leather details.

Wall Sconce WS418

Up-Light Orientation (Damp and Wet Location)



w/G4513

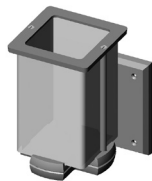

w/E403



w/E419

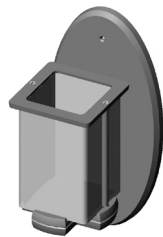

w/E560

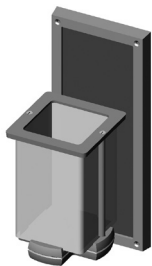

w/G153*

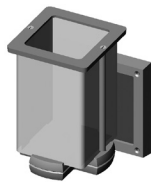

w/E155*

Down-Light Orientation (Damp Location Only)

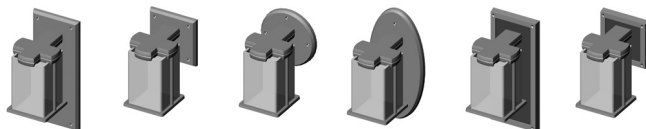

Truss-Ring Sconce

- 1 incandescent or compact fluorescent type A bulb.
- 100 watts maximum.
- Bulb not included.
- Price includes glass shade (Globe 004).
- Available for wet locations (Globe 004-W).
- * Designer escutcheon requires leather choice.



LED Truss-Ring Sconce

- Price includes LED lamp.
- Price includes glass shade (Globe 004).
- Available for wet locations (Globe 004-W).
- 120VAC, 60Hz
- 3.3 W, 2700K
- * Designer escutcheon requires leather choice.

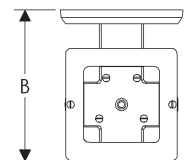
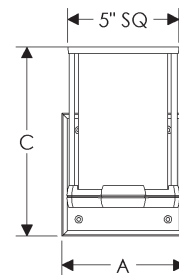

WS418	A Width	B Projecton	C Height	Shade Type	Bulb Type	Wt. lbs.	Price	LED Price
w/G4513	5 1/2"	6 3/4"	13"	Globe 004	A	11.00	\$2,052.00	\$2,234.00
w/E403	5 1/2"	6 3/4"	8 1/2"	Globe 004	A	10.00	\$2,052.00	\$2,234.00
w/E419	6 1/2"	6 3/4"	9"	Globe 004	A	10.00	\$2,052.00	\$2,234.00
w/E560	6 1/2"	6 3/4"	13"	Globe 004	A	11.00	\$2,052.00	\$2,234.00
w/G153*	5 1/2"	6 3/4"	13"	Globe 004	A	11.00	\$2,452.00	\$2,634.00
w/E155*	5 1/2"	6 3/4"	8 1/2"	Globe 004	A	10.00	\$2,379.00	\$2,561.00

- Specify metal and patina.
- See pages Tiii -Tiv for available escutcheon options.
- All LED lights are dimmable.
- Fixtures are UL listed for indoor and outdoor damp locations. A damp location is a protected area that is subject to moisture; such as under the eave of a roof.
- See page Tv-Tviii for electrical box location.
- Fixtures must be mounted independently of outlet box. Support blocking in wall is recommended.
- See page Ti for leather options. Bronze textures not available. Refer to website or brochure for leather details.

Wall Sconces

Charlie
WS419

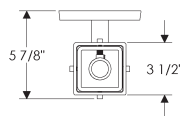
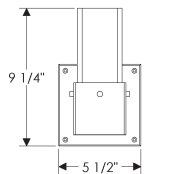
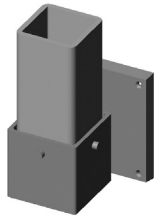

Double Charlie
WS423

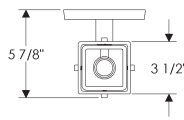
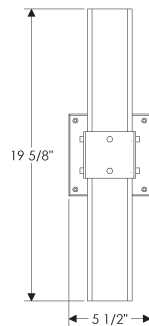
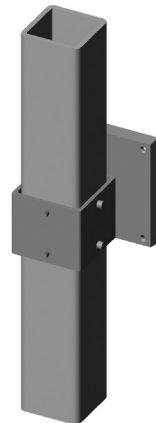

Wall Sconce

- incandescent type bulb.
- 100 watts maximum.
- Bulb not included.
- Price includes glass shade when applicable.
- * Requires leather choice.

LED Wall Sconce

- Price includes LED lamp.
- Price includes glass shade when applicable.
- 120VAC, 60Hz
- 3.3 W, 2700K (WS419)
- 6.6 W, 2700K (WS423)
- * Requires leather choice.

Wall Sconce	Escutcheon	Overall Width	Overall Projection	Overall Height	Shade Type	Bulb Type	Wt. lbs.	Price	LED Price
WS419	E280	5 1/2"	5 7/8"	9 1/4"	S Tube 001	A or T	10.00	\$1,936.00	\$2,118.00
WS419	E155*	5 1/2"	5 7/8"	9 1/4"	S Tube 001	A or T	10.00	\$2,263.00	\$2,445.00
WS423	E280	5 1/2"	5 7/8"	19 5/8"	S Tube 003	A or T	15.00	\$3,261.00	\$3,443.00
WS423	E155*	5 1/2"	5 7/8"	19 5/8"	S Tube 003	A or T	15.00	\$3,588.00	\$3,770.00
WS423	G291	4"	5 7/8"	30"	S Tube 003	A or T	15.00	\$3,261.00	\$3,443.00

- Specify metal and patina.
- See pages Tiii -Tiv for available escutcheon options.
- All LED lights are dimmable.
- Fixtures are UL listed for indoor and outdoor damp locations. A damp location is a protected area that is subject to moisture; such as under the eave of a roof.
- See page Tv-Tviii for electrical box location.
- Fixtures must be mounted independently of outlet box. Support blocking in wall is recommended.
- See page Ti for leather options. Bronze textures not available. Refer to website or brochure for leather details.

Wall Sconces

Lantern
WS465

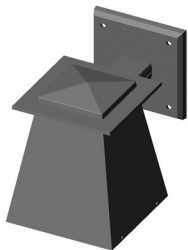

Echo
WS590

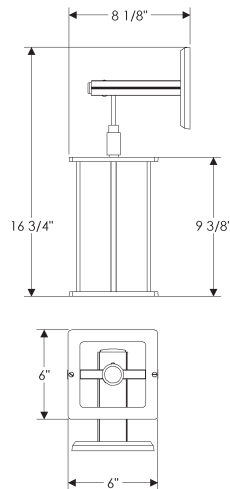
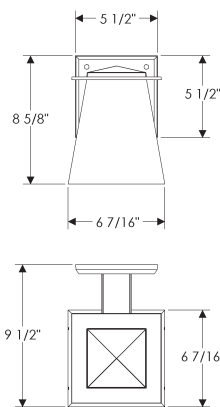
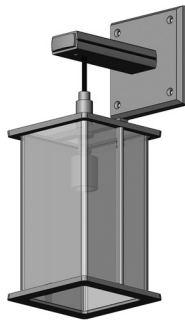

Wall Sconce

- incandescent type bulb.
- 100 watts maximum.
- Bulb not included.
- Price includes glass shade when applicable.
- * Requires leather choice.

LED Wall Sconce

- Price includes LED lamp.
- Price includes glass shade.
- 120VAC, 60Hz
- 6.6 W, 2700K (WS465)
- 3.3 W, 2700K (WS590)
- * Requires leather choice.

Wall Sconce	Escutcheon	Overall Width	Overall Projection	Overall Height	Shade Type	Bulb Type	Wt. lbs.	Price	LED Price
WS465	E403	6 7/16"	9 1/2"	8 5/8"	-	A	27.00	\$2,137.00	\$2,419.00
WS465	G4513	6 7/16"	9 1/2"	13"	-	A	30.00	\$2,137.00	\$2,419.00
WS590	E403	6"	8 1/8"	16 3/4"	Globe 005	A	12.00	\$3,406.00	\$3,588.00
WS590	E155*	6"	8 1/8"	16 3/4"	Globe 005	A	12.00	\$3,733.00	\$3,915.00

- Specify metal and patina.
- See pages Tiii -Tiv for available escutcheon options.
- All LED lights are dimmable.
- Fixtures are UL listed for indoor and outdoor damp locations. A damp location is a protected area that is subject to moisture; such as under the eave of a roof.
- See page Tv-Tviii for electrical box location.
- Fixtures must be mounted independently of outlet box. Support blocking in wall is recommended.

Wall Sconces

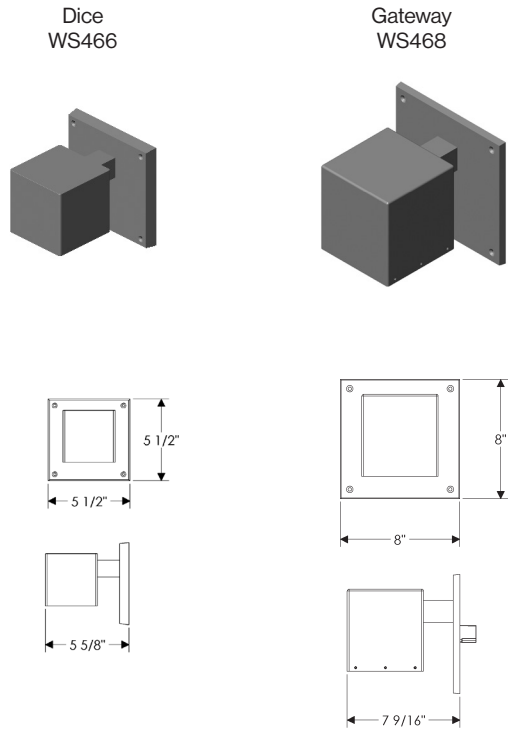

LED Wall Sconce

- Price includes LED lamp.
- Price includes glass shade when applicable.
- 120VAC, 60Hz
- 3.3 W, 2700K (WS466)
- 6.6 W, 2700K (WS468)

Wall Sconce	Escutcheon	Overall Width	Overall Projection	Overall Height	Shade Type	Bulb Type	Wt. lbs.	Price	LED Price
WS466	E280	5 1/2"	5 5/8"	5 1/2"	-	-	8.00	-	\$2,125.00
WS468	E281	8"	7 9/16"	8"	-	-	19.00	-	\$3,217.00

- Specify metal, patina, and escutcheon.
- See pages Tiii -Tiv for available escutcheon options.
- Fixtures are UL listed for indoor locations. A damp location is a protected area that is subject to moisture; such as under the eave of a roof.
- See page Tv-Tviii for electrical box location.
- Fixtures must be mounted independently of outlet box. Support blocking in wall is recommended.
- See page Ti for leather options. Bronze textures not available. Refer to website or brochure for leather details.

Wall Sconce WS500



w/G4513



w/E403



w/E419



w/E560



w/G153



w/E155

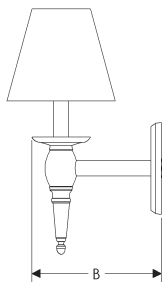
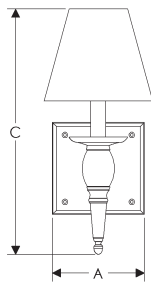

with crystals only



with prism only



with crystals & prism

Towne Sconce

- 3 incandescent or compact fluorescent type B bulbs.
- 60 watts maximum ea.
- Bulbs not included.
- Price includes fabric shade.
- * Requires leather choice.



SHADE OPTIONS

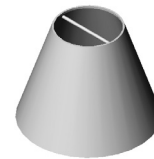

Cone 1



Drum 1

WS500	A Width	B Projection	C Height	Wt. lbs.	Option A	Option B	Option C	Option D
w/G4513	5 1/2"	7 3/4"	14 11/16"	9.50	\$1,813.00	\$1,940.00	\$1,956.00	\$2,083.00
w/E403	5 1/2"	7 3/4"	14 11/16"	6.50	\$1,813.00	\$1,940.00	\$1,956.00	\$2,083.00
w/E419	6 1/2"	7 3/4"	14 11/16"	7.00	\$1,813.00	\$1,940.00	\$1,956.00	\$2,083.00
w/E560	6 1/2"	7 3/4"	14 11/16"	9.00	\$1,813.00	\$1,940.00	\$1,956.00	\$2,083.00
w/G153*	5 1/2"	7 3/4"	14 11/16"	8.50	\$2,213.00	\$2,340.00	\$2,356.00	\$2,483.00
w/E155*	5 1/2"	7 3/4"	14 11/16"	6.50	\$2,140.00	\$2,267.00	\$2,283.00	\$2,410.00

- Specify metal and patina.
- All LED lights are dimmable.
- Fixtures are UL listed for indoor and outdoor damp locations. A damp location is a protected area that is subject to moisture; such as under the eave of a roof.
- See page Tv-Tviii for electrical box location.
- Fixtures must be mounted independently of outlet box. Support blocking in wall is recommended.

Wall Sconce WS421



w/G504

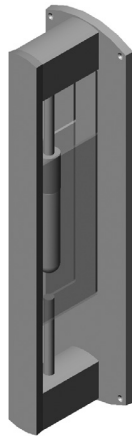

w/G520

Mod Sconce

- incandescent type 25T6.5 bulb.
- 75 watts maximum.
- Bulb included. (25 watt)
- Price includes glass shade when applicable.



LED Mod Sconce

- Price includes LED lamp.
- Price includes glass shade.
- 120VAC, 60Hz
- 3.3 W, 2700K

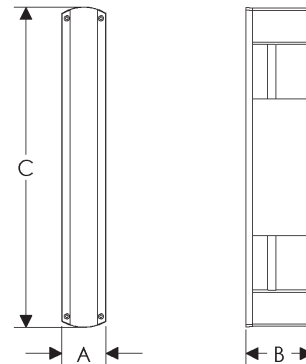

Wall Sconce	Escutcheon	A Width	B Projection	C Height	Shade Type	Bulb Type	Wt. lbs.	Price	LED Price
WS421	G504	2 3/4"	4 1/8"	20"	Mod Glass	25T6.5	14.00	\$2,094.00	\$2,276.00
WS421	G520	5"	4 1/4"	20"	Mod Glass	25T6.5	21.00	\$2,094.00	\$2,276.00

- Specify metal and patina.
- All LED lights are dimmable.
- Fixtures are UL listed for indoor and outdoor damp locations. A damp location is a protected area that is subject to moisture; such as under the eave of a roof.
- See page Tv-Tviii for electrical box location.
- Fixtures must be mounted independently of outlet box. Support blocking in wall is required.

Wall Sconce

Small Vessel
WS425



Vessel
WS430

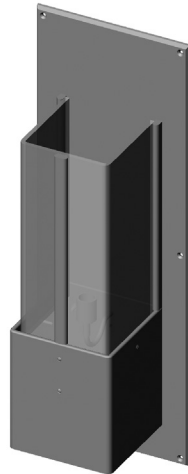

Wall Sconce

- incandescent type bulb.
- 100 watts maximum.
- Bulb not included.
- Price includes glass shade when applicable.



LED Wall Sconce

- Price includes LED lamp.
- Price includes glass shade when applicable.
- 120VAC, 60Hz
- 6.6 W, 2700K

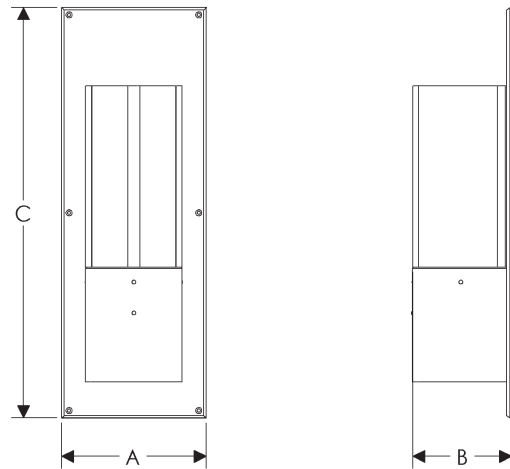

Wall Sconce	A Width	B Projection	C Height	Shade Type	Bulb Type	Wt. lbs.	Price	LED Price
WS425	8"	5 1/2"	24"	Shade 425	A	30.00	\$3,872.00	\$4,085.00
WS430	12"	8 3/16"	33 15/16"	Square Slump 7	A	85.00	\$6,261.00	\$6,472.00

- Specify metal and patina.
- All LED lights are dimmable.
- Fixtures are UL listed for indoor and outdoor damp locations. A damp location is a protected area that is subject to moisture; such as under the eave of a roof.
- See page Tv-Tviii for electrical box location.
- Fixtures must be mounted independently of outlet box. Support blocking in wall is required.

Wall Sconce

Tunnel
WS480



Double Tunnel
WS420

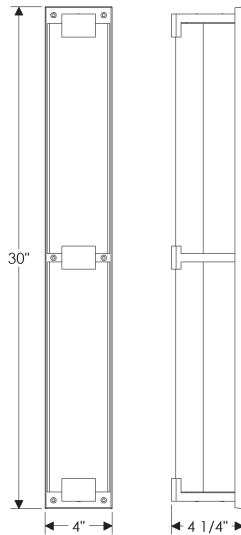
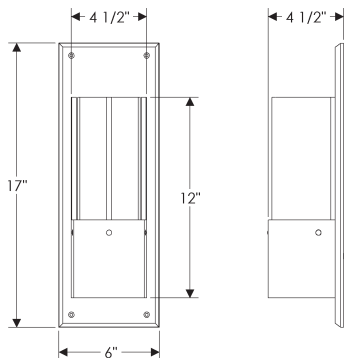
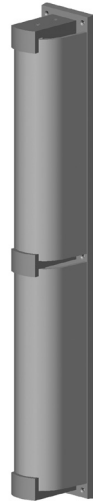

Wall Sconce

- incandescent type bulb.
- 100 watts maximum.
- Bulb not included.
- Price includes glass shade when applicable.



LED Wall Sconce

- Price includes LED lamp.
- Price includes glass shade when applicable.
- 120VAC, 60Hz
- 3.3 W, 2700K (WS480)
- 13.2 W, 2700K (WS420)

Wall Sconce	Overall Width	Overall Projection	Overall Height	Shade Type	Bulb Type	Wt. lbs.	Price	LED Price
WS480	6"	4 1/2"	17"	Curve Slump 3.5	A	18.00	\$1,864.00	\$2,046.00
WS420	4"	4 1/4"	30"	Curve Slump 4	A	30.00	\$3,321.00	\$3,685.00

- Specify metal and patina.
- All LED lights are dimmable.
- Fixtures are UL listed for indoor and outdoor damp locations. A damp location is a protected area that is subject to moisture; such as under the eave of a roof.
- See page Tv-Tviii for electrical box location.
- Fixtures must be mounted independently of outlet box. Support blocking in wall is required.

Wall Sconce

Plank, WS440
w/Flat Glass



Plank, WS445
w/Corrugated Glass

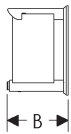
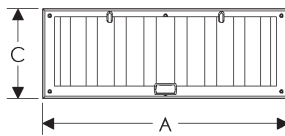
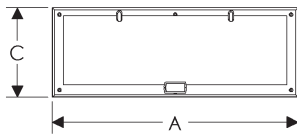
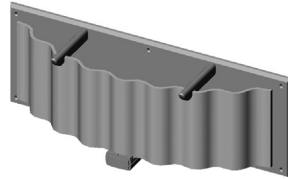

Wall Sconce

- incandescent type bulb.
- 100 watts maximum.
- Bulb not included.
- Price includes glass shade.



LED Wall Sconce

- Price includes LED lamp.
- Price includes glass shade.
- 120VAC, 60Hz
- 3.3 W, 2700K

Wall Sconce	A Width	B Projection	C Height	Shade Type	Bulb Type	Wt. lbs.	Price	LED Price
WS440	22"	5 1/4"	8"	Plank 20	A	22.00	\$2,433.00	2,615.00
WS445	22"	5 1/4"	8"	Corrugated Plank 20	A	22.00	\$2,433.00	2,615.00

- Specify metal and patina.
- Fixtures are UL listed for indoor and outdoor damp and wet locations. A damp location is a protected area that is subject to moisture; such as under the eave of a roof.
- Fixture intended to be installed utilizing NEC compliant 4" x 2" junction box. LED driver must fit within junction box. See diagram below for driver dimensions.

Pathway Light LG400

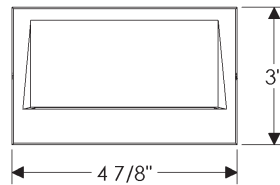
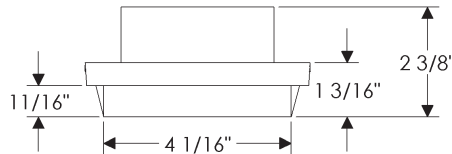
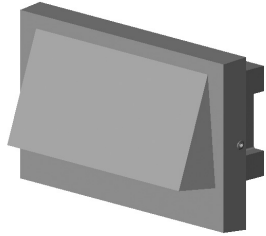

LED Horizontal Pathway Light

- 120V, 60HZ
- 2.9W, 0.03A, 3000K
- Suitable for dry, damp, & wet locations.
- Non-dimmable

Pathway Light	Overall Width	Overall Projection	Overall Height	Wt. lbs.	Price
LG400	4 7/8"	13/16"	3"	1.00	\$605.00

